



DESIGO™ RXB

## Gateway EnOcean/KNX RXZ97.1/KNX

Can be used with:

- DESIGO RXB
- Devices / Systems with KNX Communication

- 
- **Wireless receiver with KNX interface**
  - **Evaluation of up to 32 EnOcean room units**
  - **With RXB, other EnOcean functions may also be integrated: switches, window contacts, motion detectors**
  - **Other EnOcean functions (dimming, blinds, light sensors) can be realized in KNX systems**
  - **Powered via KNX bus**

## Use

---

In addition to the standard QAX3x room units, wireless units can also be integrated into the RXB room controllers. One of these technologies is called EnOcean. The energy required in the **room unit** is provided by a solar cell. A battery is only required for insufficient lighting.

The **Gateway** is powered by the KNX bus.

The integration of EnOcean room units (QAX9x.x) occurs via the gateway EnOcean/KNX, RXZ97.1/KNX. Up to 32 EnOcean room units can be integrated. The telegrams received via radio are converted into KNX communication objects.

## Type summary

---

Product No.	Stock number	Designation
RXZ97.1/KNX	S55842-Z101	Gateway EnOcean/KNX

## Ordering

---

When ordering, please specify the quantity, designation, product number and stock number.

*Example:*

**10 Gateways EnOcean/KNX RXZ97.1/KNX, S55842-Z101**

## Equipment combinations

---

EnOcean room units

Product No.	Stock number	Designation
QAX95.1	S55623-H100	Wireless and battery-less room unit with EnOcean interface (temperature sensor)
QAX96.1	S55623-H101	Wireless and battery-less room unit with EnOcean interface (temperature sensor with setpoint adjustment)
QAX95.4	S55623-H104	Wireless and battery-less room unit with EnOcean interface (temperature sensor)
QAX96.4	S55623-H105	Wireless and battery-less room unit with EnOcean interface (temperature sensor with setpoint adjuster)
QAX97.4	S55623-H106	Wireless and battery-less room unit with EnOcean interface (temperature sensor with setpoint adjuster, freely programmable button and 2-stage switch)
QAX98.4	S55623-H108	Wireless and battery-less room unit with EnOcean interface (temperature sensor with setpoint adjuster, freely programmable button and 5-stage switch)

- Notes
- The RXZ97.1/KNX can be used in all systems using KNX communication.
  - With RXB, other EnOcean functions may also be integrated: switches, window contacts, motion detectors
  - Other EnOcean functions (dimming, blinds, light sensors) can be realized in KNX systems

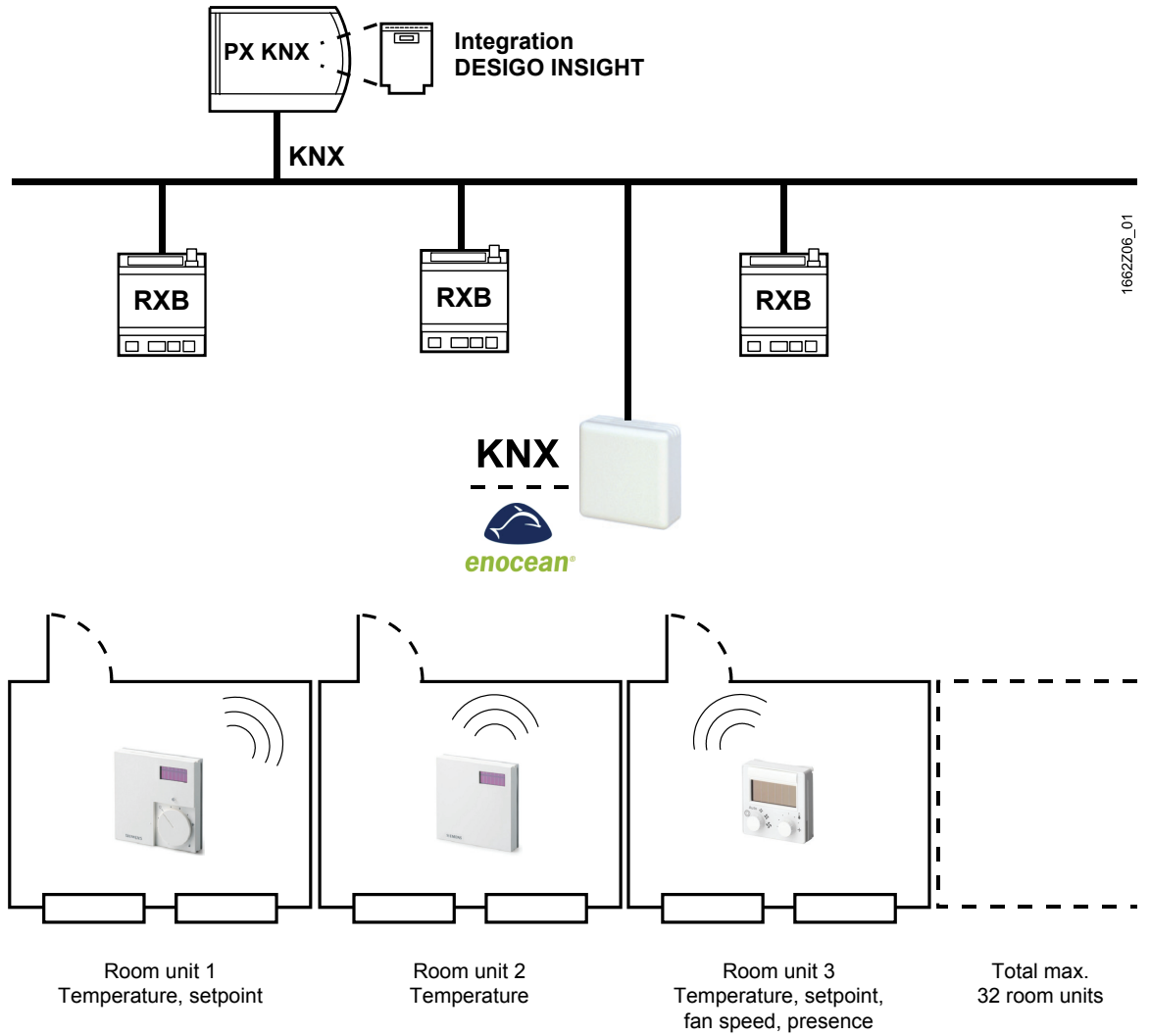

Integration of EnOcean room units in DESIGO RXB

## Mechanical design

---

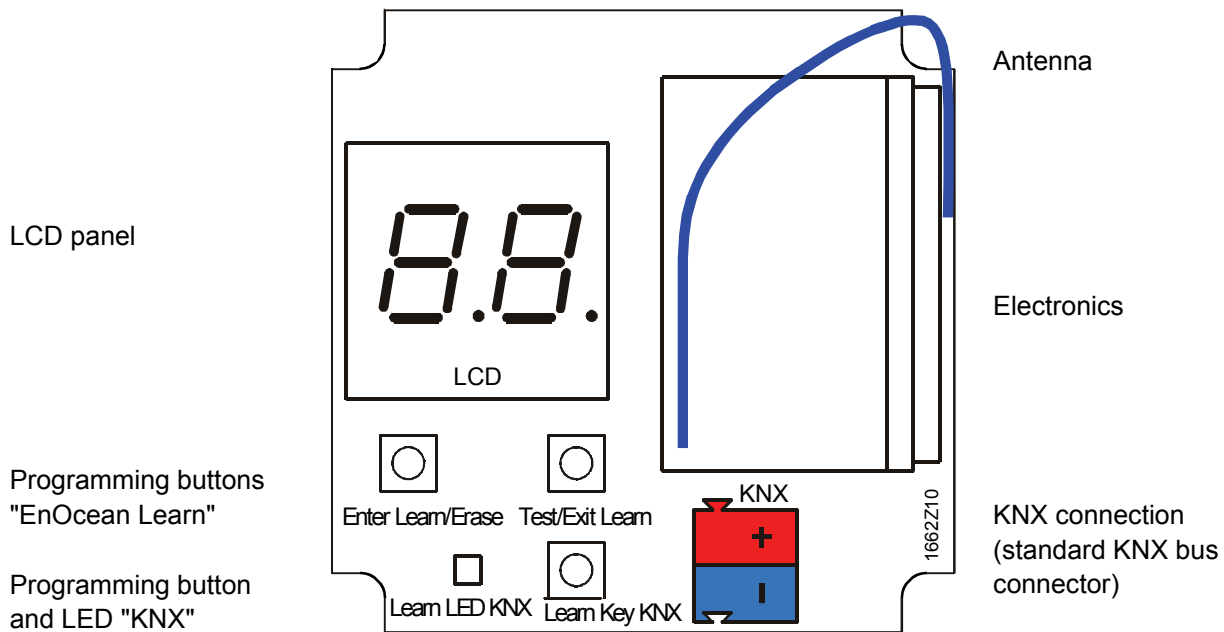

## System requirements

---

### Source software

Product data of the RXZ97.1/KNX:

Download from DESIGO intranet

[https://intra.industry.siemens.com/bt/global/en/business/building\\_comfort/systems/desigo/ra/Pages/des-ra-units.aspx?TabcardNo=6](https://intra.industry.siemens.com/bt/global/en/business/building_comfort/systems/desigo/ra/Pages/des-ra-units.aspx?TabcardNo=6)

Download from the internet:

<http://www.buildingtechnologies.siemens.com/bt/global/en/support/tools/Pages/tools.aspx?TabcardURL=/bt/global/en/support/tools/tools-tabs/Pages/Downloadsforcontroller.aspx>

### Engineering tool environment

---

Required for engineering and commissioning: a standard infrastructure using ETS.

### Restriction

---

Due to technology, a room controller RXB... with EnOcean room unit will have a lower control accuracy as a standard room unit QAX3x.

### Engineering KNX

1. Import product data for an RXB controller.
2. Import product data for the Gateways RXZ97.1/KNX.
3. Create ETS project.
4. Add device: RXB room controller.
5. Add device: Gateway RXZ97.1/KNX.
6. Parameterize room controller
7. Configure Gateway RXZ97.1/KNX:  
Configure Channel 1 as "Temperature sensor"  
(next channels: identical procedure).  
The following fields appear in the mask:

Device: 1.1.1 RXZ97.1 Gateway EnOcean

Channel	Function	Value
Channel 1	Function of channel 1	Temperature sensor
Channel 2	Sending device	Siemens QAX 9x.4
Channel 3	Slide switch / presence key	Not available
Channel 4	Set point adjustment	Not available
Channel 5	Multiple contact switch	Not available

When using the presence key, change "Slide switch / Presence key" to "Presence key".

Device: 1.1.1 RXZ97.1 Gateway EnOcean

Channel	Function	Value
Channel 1	Function of channel 1	Temperature sensor
Channel 2	Sending device	Siemens QAX 9x.4
Channel 3	Slide switch / presence key	Presence key
Channel 4	Set point adjustment	Not available
Channel 5	Multiple contact switch	Not available

When selecting the setpoint adjustment to "Available", the additional entry fields for the setpoint limits appear:

Device: 1.1.1 RXZ97.1 Gateway EnOcean

Channel 1	Function of channel 1	Temperature sensor
Channel 2	Sending device	Siemens QAX 9x.4
Channel 3	Slide switch / presence key	Presence key
Channel 4	Set point adjustment	Available
Channel 5	Left limit (in °C)	-3
Channel 6	Right limit (in °C)	3
Channel 7	Multiple contact switch	Not available

When using the multiple contact switch, change "Multiple contact switch" to "Available".

You can leave the default values of the 3 fan speeds.

For correct fan control with the RXB, set "Automatic state inversion" to "Yes (Automatic = 0)".

Device: 1.1.1 RXZ97.1 Gateway EnOcean

Channel 1	Function of channel 1	Temperature sensor
Channel 2	Sending device	Siemens QAX 9x.4
Channel 3	Slide switch / presence key	Presence key
Channel 4	Set point adjustment	Available
Channel 5	Left limit (in °C)	-3
Channel 6	Right limit (in °C)	3
Channel 7	Multiple contact switch	Available
Channel 8	Fan speed 1 (in %)	33
Channel 9	Fan speed 2 (in %)	66
Channel 10	Fan speed 3 (in %)	100
Channel 11	Automatic state inversion	Yes (Automatic = 0)

8. Create group addresses.
9. Bind group addresses with room controller.
10. Bind group address with Gateway RXZ97.1/KNX.

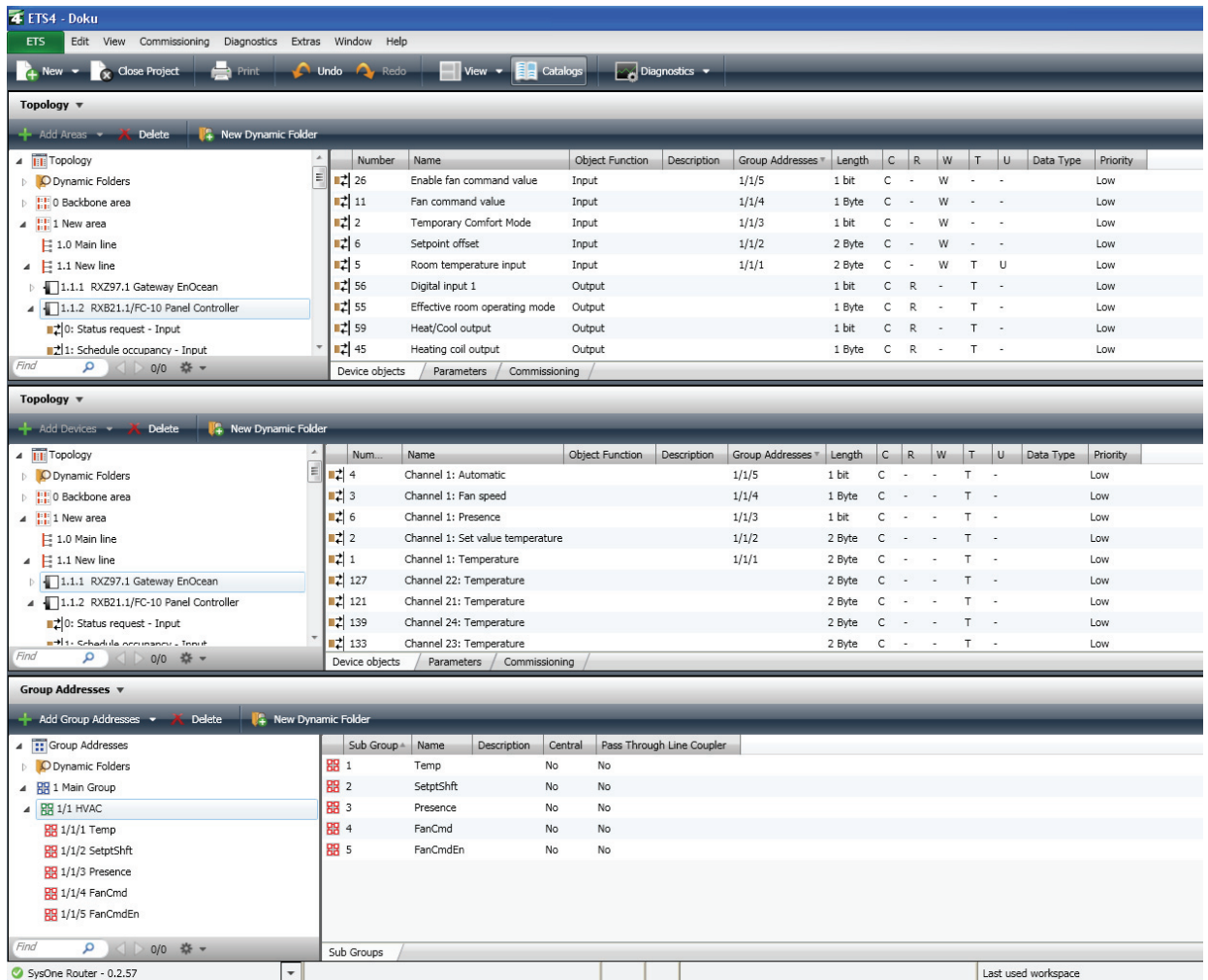

### 11. Download addresses.

A new Gateway RXZ97.1/KNX has the physical address 15.15.255.  
No group addresses and bindings are occupied to EnOcean devices.

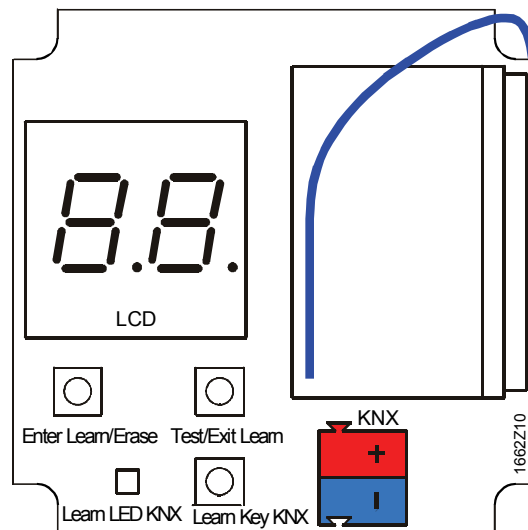

Press the programming key (**Learn Key KNX**) to program physical addresses (EIB/KNX) via the ETS.  
The red LED (**Learn LED KNX**) starts to light up. It goes out again when the device successfully receives the physical address.

### 12. Download application data ("Partial download" only!).

### Link to EnOcean devices

The functions of individual channels must be programmed using the ETS prior to linking to EnOcean devices.  
One EnOcean room unit can be learned per channel.

### Learning mode

The two buttons under the displays are used to operate EnOcean device learning:

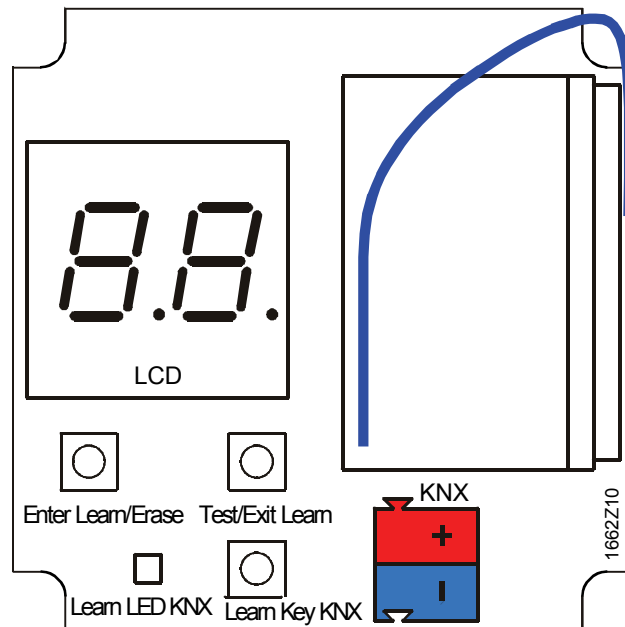

### Command keys

- Left short: **Enter Learn:** Start learning mode (from normal operation)
- Left short: **Enter Learn:** Next channel (within learning mode)
- Left long: **Erase:** Delete channel
- Right short: **Test:** Send test telegram(s)
- Right long: **Exit Learn:** Exit learning mode

"Long press" = longer than 2 seconds.

### Procedure

1. Start learning mode (left short **Enter Learn**)
2. Select the first channel (left short **Enter Learn**)  
The display indicates the current channel number alternating with the number of connected EnOcean devices.  
Example: d.0 – 1 – d.0 – 1 means:  
no room unit (d) is connected; only 1 room unit per channel allowed.
3. Press learning button on the room unit.  
This activates the EnOcean connection.
4. Test (right short **Test**)  
The communication objects connected to this channel are sent on the KNX bus, if the group address is occupied.
5. Exit learning mode (left long **Exit Learn**)  
The Gateway RXZ97.1/KNX automatically exits learning mode:  
when no operation occurs within 5 minutes.



## Delete assignments

EnOcean links to EnOcean devices can be deleted as follows:

- Left long **Erase:** Delete channel (in the learning mode)



### Note!

- **Changing the parameters or the group addresses for the gateway by means of the ETS will delete all EnOcean links if a complete download is performed.**

Perform a "Partial download" to keep existing EnOcean links (after changes / extension of a system).

## Normal operation

- If the telegram of an EnOcean device was received during normal operation, each channel checks if this is "his" device. If yes, the number associated with the channel is displayed shortly on the LCD, and one or more of telegrams corresponding to the function is sent on the KNX bus.
- The EnOcean device determines the transmission frequency:
  - The Gateway s only ends telegrams on the KNX bus, when the appropriate EnOcean telegrams were received.
  - It displays zero when a received EnOcean telegram is not assigned to a channel.

## Additional EnOcean functions

The various sensor types are displayed as follows in the LCD for the Gateways RXZ97.1/KNX:

- A: Switching
- b: Dimming with stop telegram
- C: Blinds
- d: Temperature sensor
- E: Window contract
- F: Other sensor

Up to four links per channel can be learned for button sensors and window contacts.

Only one EnOcean device can be learned per channel for temperature sensors, lighting sensors, motion detectors and binary inputs.

## Mounting

---

The devices are supplied ready for operations.

You can mount it to the wall with brads and screws (no included).

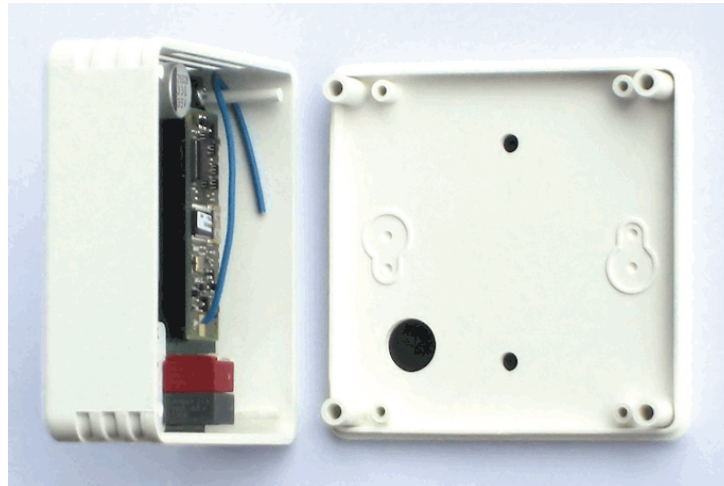

A 868 MHz reception antenna is built in

### Notes on reception

- The device should be mounted 1 meter below the ceiling in rooms.
- Distance to other transmitters (GSM / DECT / Wireless LAN / EnOcean, etc.) should be at least 2 meters.

For details on positioning of the EnOcean **room units** (transmitters), refer to data sheet CM2N1660.

## Disposal

---



The device is classified as waste electronic equipment in terms of the European Directive 2002/96/EC (WEEE) and should not be disposed of as unsorted municipal waste.

The relevant national legal rules are to be adhered to.

Regarding disposal, use the systems setup for collecting electronic waste.

Observe all local and applicable laws.

## Technical data

General device data	Operating voltage (from KNX bus)	DC 24 V
	Power consumption	Approx. 25 mA
	Interface	KNX
	Connection terminals	Standard KNX bus connector
	Mounting	Flush mount.
	Degree of protection (mounted)	IP20 per EN60529
Ambient conditions	Operating	
	Temperature	-5...45 °C
	Humidity	5...93% relative humidity (non-condensing)
	Transport, storage	
Temperature	-25...70 °C	
Humidity	5...93% relative humidity (non-condensing)	
CE conformity	Electromagnetic compatibility	89/336/EEC
	Radio and Telecommunications Terminal Equipment Directive	R&TTE 1999/5/EC
	RoHS	Reduction of hazardous substances
	2002/95/EC	2002/95/EC
Standards	Electromagnetic compatibility	
	Immunity	EN 61000-6-2
	Emissions	EN 61000-6-3
	Home and Building Electronic System (HBES)	EN 50090-2-2
Housing	Material	Plastic which"
	Color	White
Weight	With / without packaging	70 g / 110 g

## Connection terminals

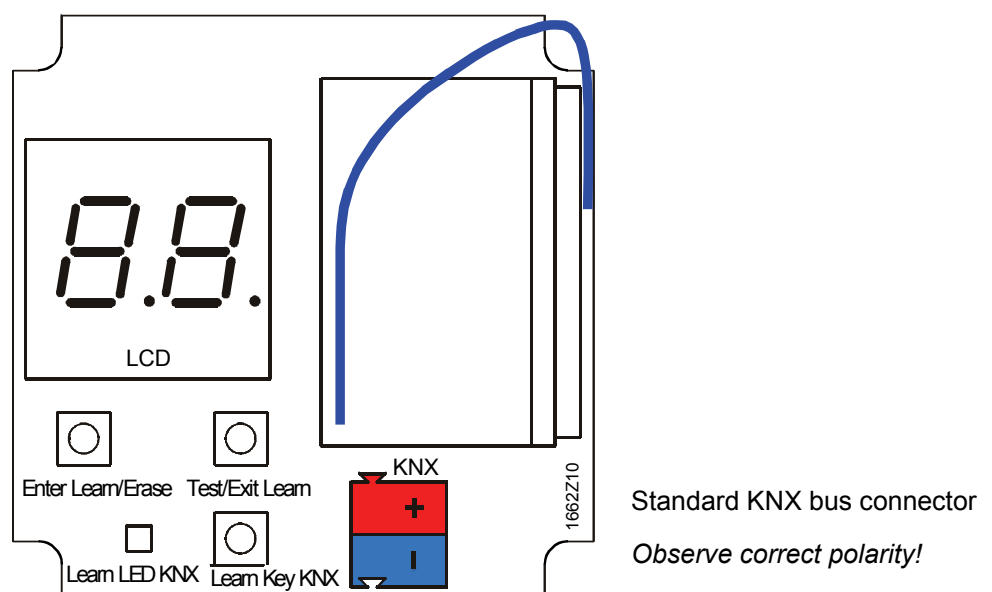

## Dimensions

All dimensions in mm

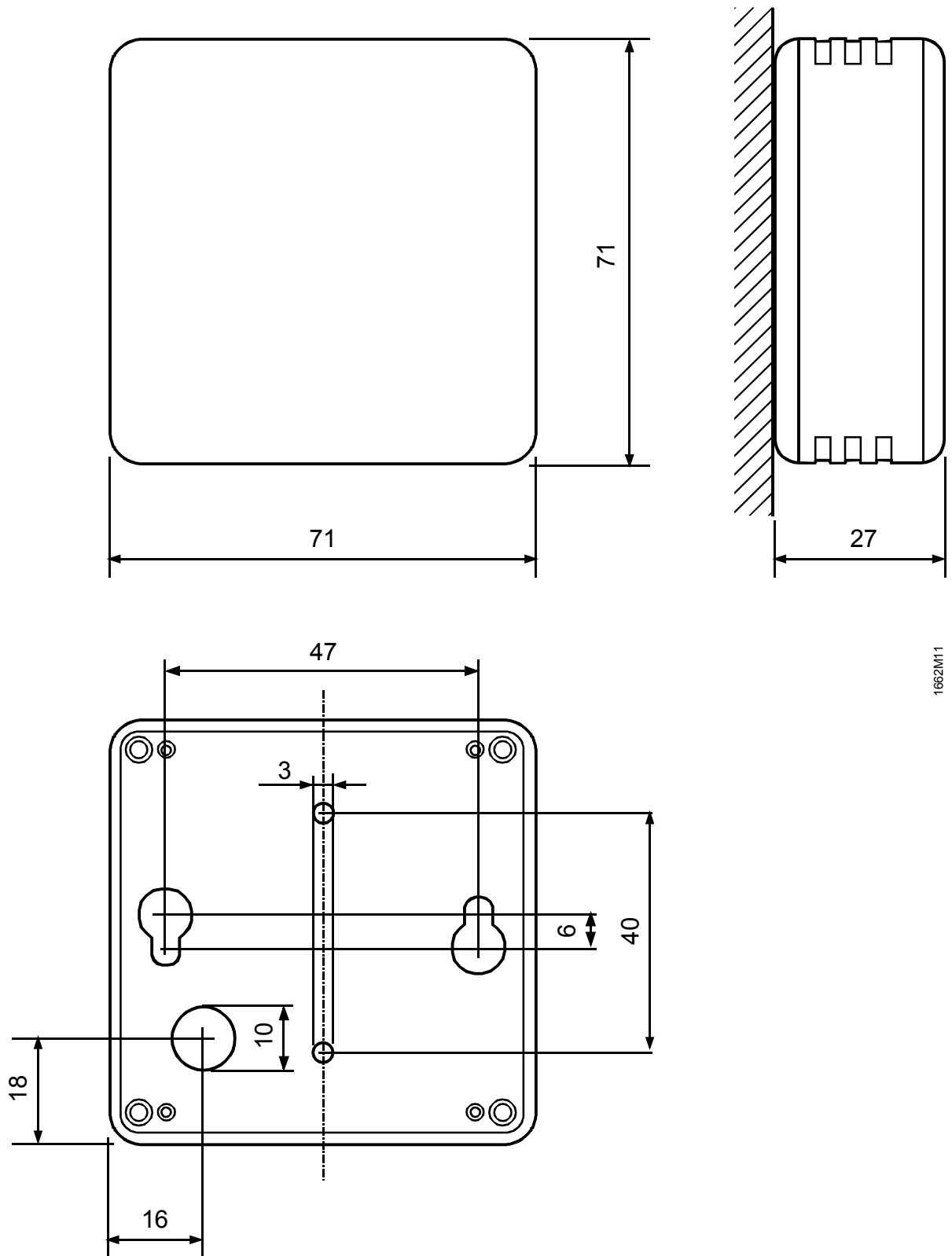

1662M11