



## Room Temperature Controllers with LCD

## RDD10...

for heating systems

---

**2-position control with ON / OFF output for heating**  
**Operating modes: normal operation and energy saving mode**  
**Automatic operating mode change over as an option**  
**Mains-powered AC 230 V (RDD10) or battery-powered DC 3 V (RDD10.1)**

### Use

---

The RDD10... is used for the control of the room temperature in heating systems.

Typical applications:

- Apartments
- Commercial spaces
- Schools

For the control of the following pieces of equipment:

- Thermic valves or zone valves
- Gas or oil burners
- Fans
- Pumps

## Functions

The controller acquires the room temperature with its integrated sensor and maintains the setpoint by delivering control commands. The switching differential is 1 K.

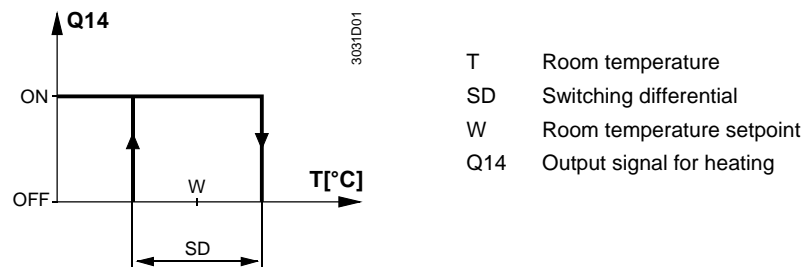

## Operating modes

The RDD10... provides normal operation and, optionally, energy saving mode or OFF. The difference between normal operation and energy saving mode is only the room temperature setpoint. The changeover from normal operation to energy saving mode, and vice versa, is made by pressing a button.

### Normal operation

When normal operation is activated, symbol “☀” appears on the display. The setpoint can be readjusted by pressing buttons  $\oplus$  and  $\ominus$ .

### Energy saving mode or OFF

When energy saving mode is activated, symbol “☾” appears on the display. The setpoint can be readjusted by pressing buttons  $\oplus$  and  $\ominus$ . When the energy saving setpoint is set to “0”, the controller is switched off, that is, the RDD10... is not active in energy saving mode. In that case, symbol “☾” does not appear.

### Automatic operating mode change over

When this function is activated and a manual changeover has been made, the operating mode will automatically be reset on completion of an adjustable period of time. This period of time can be adjusted with buttons  $\oplus$  and  $\ominus$  after pressing the hour glass button.

The operating action of the reset depends on the setting of the DIL switch, from normal operation to energy saving mode / OFF, or vice versa. The operating mode can be manually reset before the delay time has elapsed. When the delay is active, the hour glass symbol appears on the display.

### Display

The digital display shows the actual room temperature and the symbol of the operating mode currently active. When the heating output is activated, the triangle symbol appears. When the function “automatic operating mode change over” is activated, the hour glass symbol is shown.



Display in normal operation



Display in energy saving mode

## Type summary

Type reference	Features
<b>RDD10</b>	Mains-powered AC 230 V
<b>RDD10.1</b>	Battery-powered DC 3 V

## Ordering

When ordering, please give name and type references, e.g. **room temperature controller RDD10**.

Valve actuators are to be ordered as separate items.

## Equipment combinations

Type of unit	Type reference	Data sheet
Motoric on/off actuator	<b>SFA21...</b>	4863
Thermal actuator (for radiator valve)	<b>STA21...</b>	4893
Thermal actuator (for small valve 2,5 mm)	<b>STP21...</b>	4878

## Accessories

Description	Type reference
Adapter plate 120 x 120 mm for 4" x 4" conduit boxes	ARG70
Adapter plate 96 x 120 mm for 2" x 4" conduit boxes	ARG70.1
Adapter plate for surface wiring 112x130 mm	ARG70.2

## Mechanical design

The unit consists of two parts:





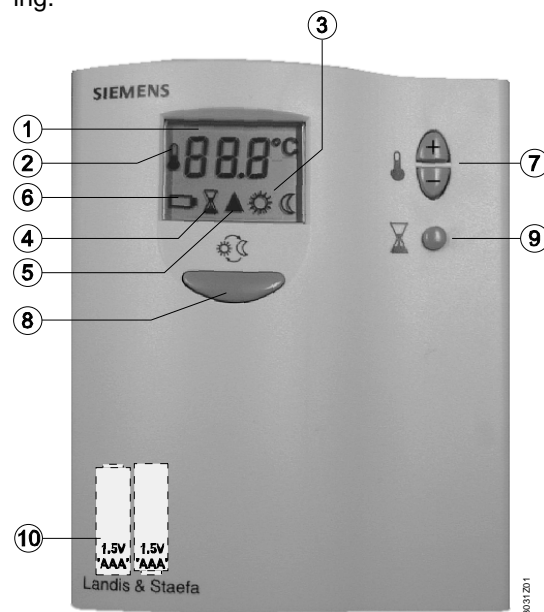

- A plastic housing with digital display, which accommodates the electronics, the operating elements and the built-in room temperatures sensor
- A mounting base

The housing engages in the mounting base and snaps on.

The base carries the screw terminals. The DIP switch is located at the rear of the housing.



## Legend

- 1 Display of the room temperature, setpoints or operating mode changeover time
- 2  symbol when actual room temperature is displayed
- 3  Normal operation
- 4  Energy saving mode
- 4  symbol when displaying the operating mode changeover time or when the operating mode changeover function is activated
- 5  heating on
- 6  symbol indicating that batteries need to be replaced (only with battery-powered versions)
- 7 Buttons for adjusting the setpoint and the operating mode changeover time
- 8  Button for operating mode changeover "Normal operation ↔ energy saving mode"
- 9 Button for adjusting the operating mode changeover time
- 10 Battery compartment (only with battery-powered versions)

The required room temperature setpoints for normal operation and energy saving mode and the operating mode changeover time are adjusted with buttons. Operating mode changeover can be triggered by pressing a button.

The operating action for the automatic operating mode changeover function is selected with a DIP switch.

DIP switch no.	Meaning	Position ON	Position OFF
1	Operating action of automatic operating mode changeover	Automatic operating mode changeover from normal operation to energy saving mode or OFF	Automatic operating mode change over from energy saving mode or OFF to normal operation

## Notes

The room temperature controller should be mounted in a location where the air temperature can be measured as accurately as possible without getting adversely affected by direct solar radiation or other heat or refrigeration sources.

Mounting height is about 1.5 m above the floor.

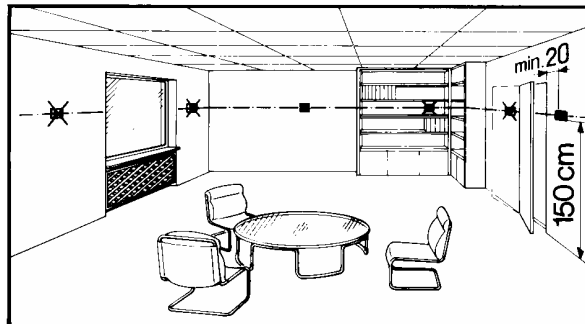

The unit can be fitted to a recessed conduit box.

- Only authorised staff may open the controller.  
**Caution: AC 230 V!**
- The cables used must satisfy the insulation requirements with regard to mains potential







## Mounting, installation and commissioning

When mounting the unit, fix the baseplate first. Then, make the electrical connections and fit and secure the cover (also refer to Mounting Instructions).

The controller must be mounted on a flat wall and in compliance with local regulations.

If there are thermostatic radiator valves in the reference room, they must be set to their fully open position.

**Maintenance** The controller is maintenance-free.

**Sensor calibration** If the temperature on the display does not agree with the room temperature effectively measured, the temperature sensor can be recalibrated. For that purpose, both buttons  and  must be pressed simultaneously for 3 seconds. Then, the temperature displayed can be changed by a maximum of +/- 3 Kelvin by pressing the  and  buttons. Five seconds after the last push of a button, the controller will automatically return to the normal operational statuses.

**Change of batteries (only with battery-powered versions)** If the battery symbol appears, the battery power is almost exhausted and the batteries should be replaced.

### Technical data

 Power supply	Operating voltage	
	• RDD10 at L - N	AC 230 V +10/-15 %
	• RDD10.1	DC 3 V (2 x 1.5 V AAA Alkaline batteries)
	Frequency (RDD10)	50 or 60 Hz
	Power consumption (RDD10)	4VA
Control outputs	Battery life (RDD10.1)	> 1 years (AAA Alkaline batteries)
	Control output Q12 (N.C. contact)	
	Rating RDD10 (AC 230 V)	max. 5(2) A
	Rating RDD10.1 (AC 24...250 V)	max. 5(2) A
	Control output Q14 (N.O. contact)	
	Rating RDD10 (AC 230 V)	max. 5(2) A
Functional data	Rating RDD10.1 (AC 24...250 V)	max. 5(2) A
	Switching differential SD	1 K
	Setpoint setting range	5...35 °C (normal operation) 0 (OFF) and 5...35 °C (energy saving mode)
	Increments	0.5 °C
	Factory setting normal operation	20 °C
	Factory setting energy saving mode	8 °C
	Setting range of operating mode	
	changeover time	0.5...24 h
	Increment	0.5 h
	Factory setting	0 h (not activated)
Environmental conditions	Operation	to IEC 721-3-3
	Climatic conditions	class 3K5
	Temperature	0...+50 °C
	Humidity	<95 % r. h.
	Transport	to IEC 721-3-2
	Climatic conditions	class 2K3
	Temperature	-25...+60 °C
	Humidity	<95 % r. h.
	Mechanical conditions	class 2M2
	Storage	to IEC 721-3-1
	Climatic conditions	class 1K3
	Temperature	-25...+60 °C
	Humidity	<95 % r. h.

Norms and standards

<b>CE</b> conformity to	
EMC directive	89/336/EEC
Low voltage directive	73/23/EEC and 93/68/EEC
<b>C<sup>N474</sup></b> <b>C-Tick</b> conformity to	
EMC emission standard	AS/NSZ 4251.1:1994
Product standards	
Automatic electrical controls for household and similar use	EN 60 730 – 1 and EN 60 730 – 2 - 9
Electromagnetic compatibility	
Emissions	IEC/EN 61 000-6-3
Immunity	IEC/EN 61 000-6-1
Safety class	II to EN 60730
Pollution class	normal
Degree of protection of housing	IP30 to EN 60529
Connection terminals for	use solid wires or prepared stranded wires 2 x 1.5 mm <sup>2</sup> or 1 x 2.5 mm <sup>2</sup> (min. 0.5 mm <sup>2</sup> )
Weight	0.20 kg
Colour of housing front	white, NCS S 0502-G (RAL9003)

General

## Connection diagram

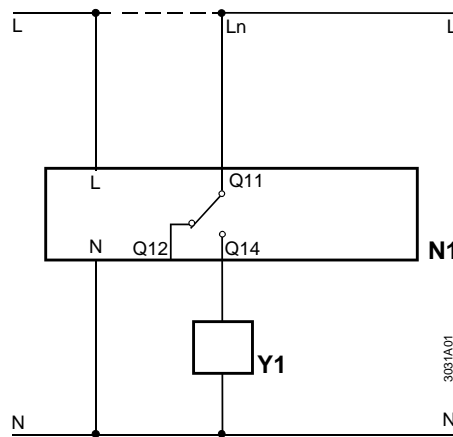

RDD10

**N1** Room temperature controller  
**Y1** Regulating unit  
**L, Ln** Live, AC 230 V  
**N** Neutral, AC 230 V

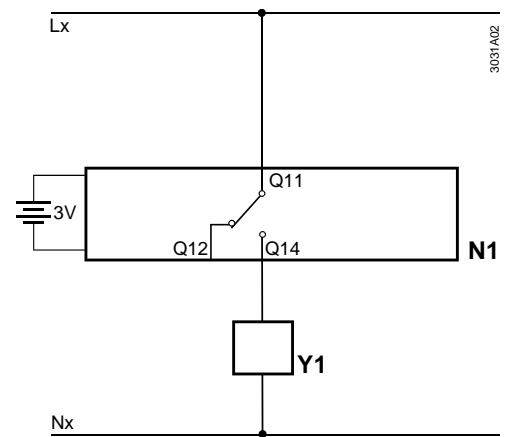

RDD10.1

**Lx** Live, AC 24 ... 250 V  
**Q11, Q12** N.C. contact (for N.O. valves)  
**Q11, Q14** N.O. contact (for N.C. valves)  
**Nx** Neutral, AC 24 ... 250 V

## Application examples

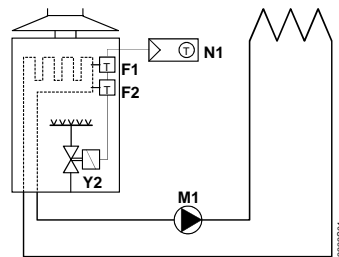

Room temperature controller with direct control of a gas-fired wall-hung boiler

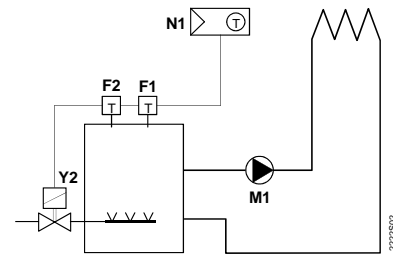

Room temperature controller with direct control of a gas-fired floor-standing boiler

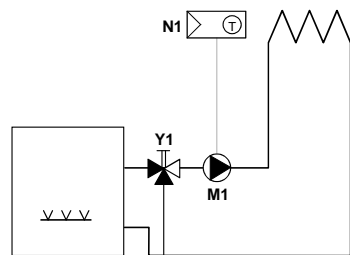

Room temperature controller with direct control of a heating circuit pump (pre-control by manual mixing valve)

**F1** Thermal reset limit thermostat  
**F2** Safety limit thermostat  
**M1** Circulating pump

**N1** RDD10... room temperatures controller  
**Y1** Three-port valve with manual adjustment  
**Y2** Magnetic valve

## Dimensions

### Controller

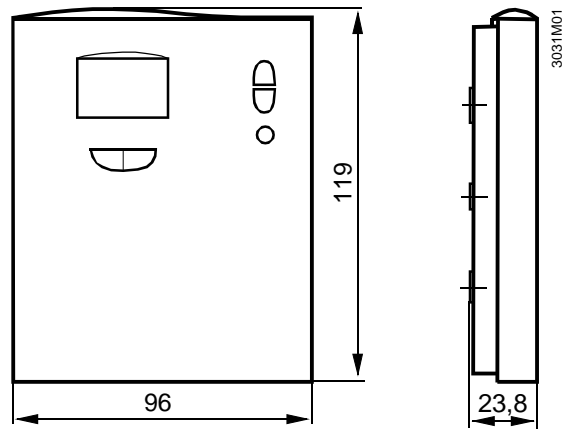

### Baseplate

