

## Room thermostats with KNX communications

**RDG100KN**  
**RDG160KN**

- For fan coil unit applications
- For universal applications
- For use with compressor in DX type equipment

- 
- **KNX bus communication (S-mode and LTE mode)**
  - **Backlit display**
  - **2P / PI / P control**
  - **Outputs for on/off, PWM, 3-position or DC 0...10 V control**
  - **Outputs for 3-speed, 1-speed, or DC (DC 0...10 V) fan**
  - **3 multifunctional inputs for keycard contact, external sensor, etc.**
  - **Operating modes: Comfort, Economy and Protection**
  - **Automatic or manual fan speed control**
  - **Automatic or manual heating / cooling changeover**
  - **Minimum and maximum limitation of room temperature setpoint**
  - **Control depending on the room or the return air temperature**
  - **Selectable relay output functions (RDG160KN)**
  - **Adjustable commissioning and control parameters**
  - **Commissioning with Synco ACS, ETS or via local HMI**
  - **Integration into Synco**
  - **Integration into Desigo via group addressing (ETS) or via individual addressing**
  - **Integration into third-party system via group addressing (ETS)**
  - **Operating voltage:**  
RDG100KN: AC 230 V  
RDG160KN: AC 24 V

The RDG1...KN room thermostats are designed for use with the following types of system:

**Fan coil units** via ON/OFF or modulating / DC control outputs:

- 2-pipe system
- 2-pipe system with electric heater
- 2-pipe system and radiator / floor heating
- 4-pipe system
- 4-pipe system with electric heater (RDG100KN)
- 2-stage heating or cooling system

**Chilled / heated ceilings (or radiators)** via ON/OFF or modulating / DC control outputs:

- Chilled / heated ceiling
- Chilled / heated ceiling with electric heater
- Chilled / heated ceiling and radiator / floor heating
- Chilled / heated ceiling, 2-stage cooling or heating

**Compressor application** via On/Off control (RDG160KN)

- Compressors in DX-type equipment
- Compressors in DX-type equipment with electric heater
- Compressors in DX-type equipment with Radiator
- 2-stage compressors in DX-type equipment for heating or cooling

**The RDG100KN controls ...**

- One single or 3-speed fan
- One or two on/off / PWM / 3-position valve actuators
- One valve actuator and one electric heater / Radiator

**The RDG160KN controls ...**

- One single, 3-speed or DC 0...10 V fan
- One or two on/off valve actuators / el. Heater / radiator with DC fan
- One or two DC valve actuators / el. Heater / radiator with DC fan
- One or two DC valve actuators / el. Heater / radiator with 1 / 3-speed fan
- One on/off valve actuator, one DC valve actuator with DC fan
- 1 or 2-stage compressor in DX-type equipment, with electric heater / radiator

Used in systems with:

- Heating or cooling mode
- Automatic heating/cooling changeover
- Manual heating/cooling changeover
- Heating and cooling mode (e.g. 4-pipe system)

The room thermostats are delivered with a fixed set of applications.

The relevant application is selected and activated during commissioning using one of the following tools:

- Synco ACS
- ETS
- Local DIP switch and HMI

- Room temperature control via built-in temperature sensor or external room temperature / return air temperature sensor
- Changeover between heating and cooling mode (automatic via local sensor or bus, or manual)
- Selection of applications via DIP switches or commissioning tool (ACS, ETS)
- Select operating mode via operating mode button on the thermostat
- Parameters download with commissioning tool (ACS, ETS)
- Temporary Comfort mode extension
- Single speed, 3-speed or DC 0...10 V fan control (automatic or manual)
- Display of current room temperature or setpoint in °C and/or °F
- Minimum and maximum limitation of room temperature setpoint
- Button lock (automatic or manual)
- 3 multifunctional inputs, freely selectable for:
  - Operating mode switchover contact (keycard, window contact, etc.)
  - Sensor for automatic heating / cooling changeover
  - External room temperature or return air temperature sensor
  - Dewpoint sensor
  - Electric heater enable
  - Fault input
  - Monitor input for temperature sensor or switch status
  - Supply air temperature sensor (RDG160KN)
- Advanced fan control function, e.g. fan kick, fan start delay, selectable fan operation (enable, disable or depending on heating or cooling mode)
- Purge function together with 2-port valve in a 2-pipe changeover system
- Reminder to clean fan filters
- Floor heating temperature limitation
- Minimum and maximum supply air temperature limitation (RDG160KN)
- Reload factory settings for commissioning and control parameters
- KNX bus (terminals CE+ and CE-) for communication with Synco or KNX compatible devices
- Display of outside temperature or time of day via KNX bus
- Time scheduling and central control of setpoints via KNX bus
- With a Synco RMB7xx controller, the energy demand signal of the thermostat is used to optimize energy supply
- Selectable relay function for switching external equipment (RDG160KN)

# Applications

The thermostats support the following applications, which can be configured using the DIP switches at the rear of the unit or a commissioning tool.

## Remote configuration

DIP switches 1...3 need to be set to OFF (remote configuration, factory setting) to select an application via commissioning tool.

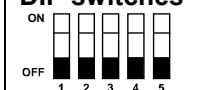
<p><b>Remote configuration, via commissioning tool (factory set)</b></p> <ul style="list-style-type: none"> <li>• Synco ACS</li> <li>• ETS</li> </ul>	<p><b>DIP switches</b></p> 
-------------------------------------------------------------------------------------------------------------------------------------------------------	----------------------------------------------------------------------------------------------------------------

## Applications for fan coil systems

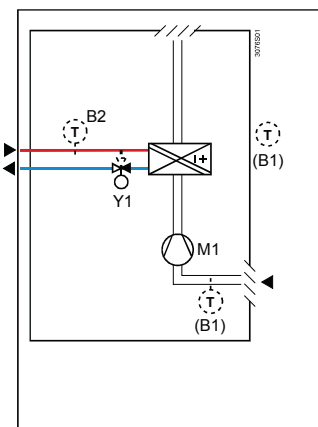
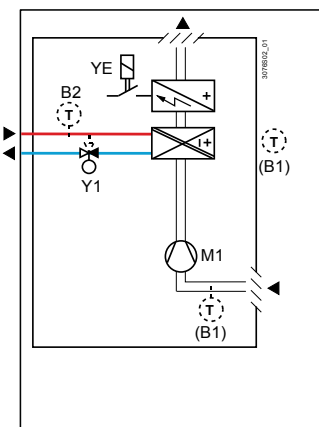
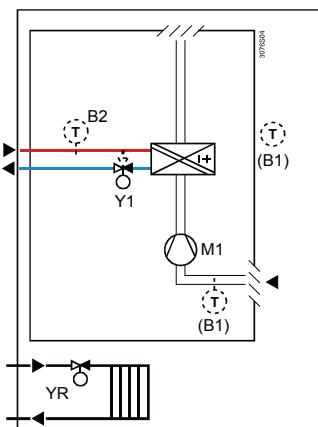
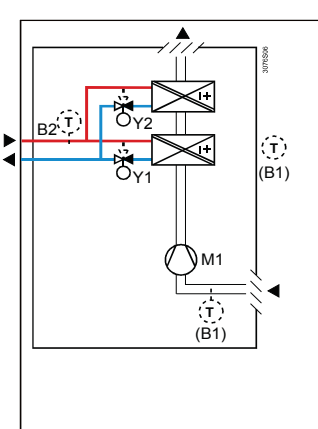
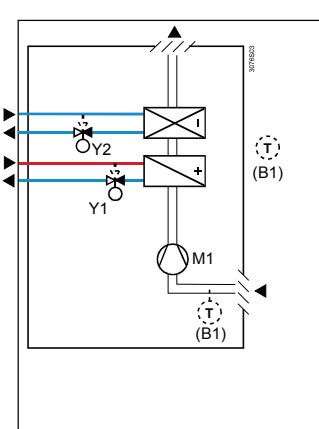
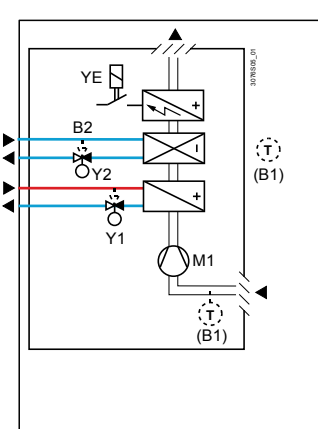
Applications, DIP setting, Control outputs														
<p>• 2-pipe fan coil unit</p>  <p>Using RDG100KN, RDG160KN</p>	<p>• 2-pipe fan coil unit and electric heater</p>  <p>Using RDG100KN, RDG160KN</p>	<p>• 2-pipe fan coil unit and radiator / floor heating</p>  <p>Using RDG100KN, RDG160KN</p>												
<p>• 2-pipe / 2-stage fan coil unit</p>  <p>Using RDG100KN, RDG160KN</p>	<p>• 4-pipe fan coil unit</p>  <p>Using RDG100KN, RDG160KN</p>	<p>• 4-pipe fan coil unit and electric heater</p>  <p>Using RDG100KN</p>												
<table border="1" style="width: 100%; border-collapse: collapse;"> <thead> <tr style="background-color: #cccccc;"> <th style="width: 20%;">Product no.</th> <th style="width: 30%;">Control outputs</th> <th style="width: 50%;">Fan</th> </tr> </thead> <tbody> <tr> <td>RDG100KN</td> <td>On/off, PWM, 3-position</td> <td>3-speed, 1-speed</td> </tr> <tr> <td>RDG160KN</td> <td>DC 0...10 V</td> <td>3-speed, 1-speed, DC 0...10 V</td> </tr> <tr> <td>RDG160KN</td> <td>On/off</td> <td>DC 0...10 V</td> </tr> </tbody> </table>			Product no.	Control outputs	Fan	RDG100KN	On/off, PWM, 3-position	3-speed, 1-speed	RDG160KN	DC 0...10 V	3-speed, 1-speed, DC 0...10 V	RDG160KN	On/off	DC 0...10 V
Product no.	Control outputs	Fan												
RDG100KN	On/off, PWM, 3-position	3-speed, 1-speed												
RDG160KN	DC 0...10 V	3-speed, 1-speed, DC 0...10 V												
RDG160KN	On/off	DC 0...10 V												

## Applications for Universal systems

### Applications, DIP setting, Control outputs

- Chilled / heated ceiling

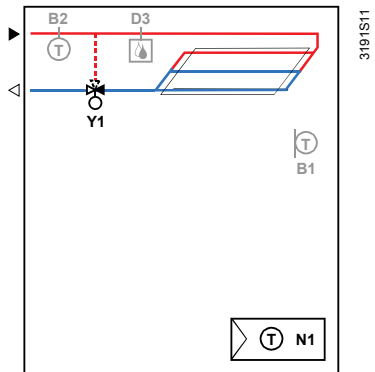

Using RDG100KN, RDG160KN

- Chilled / heated ceiling and electric heater

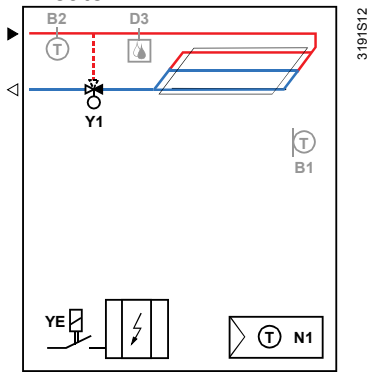

Using RDG100KN, RDG160KN

- Chilled / heated ceiling and radiator / floor heating

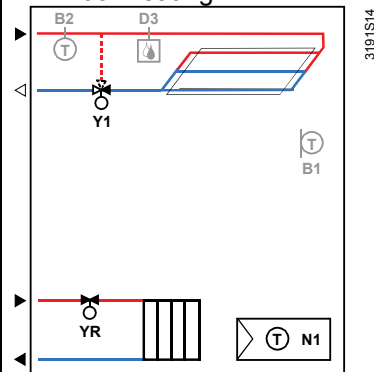

Using RDG100KN, RDG160KN

- 2-stage chilled / heated ceiling

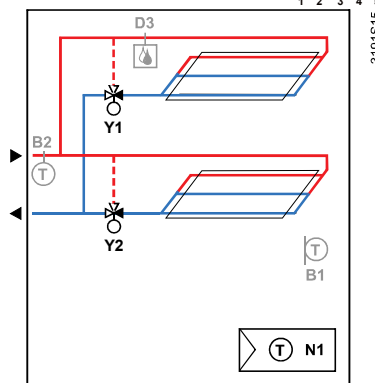

Using RDG100KN, RDG160KN

- Chilled ceiling and radiator

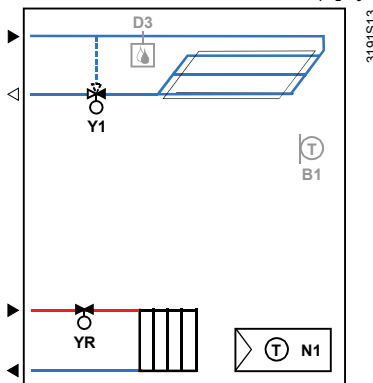

Using RDG100KN, RDG160KN

Product no.	Control outputs
RDG100KN	On/off, PWM, 3-position
RDG160KN	DC 0...10 V

**Applications for heat pump systems (RDG160KN)**

**Applications, DIP setting, Control outputs**

• Heated or cooled with compressors

Using RDG160KN

• Heated or cooled with compressors, with electric heater

Using RDG160KN

• Heated and cooled with compressors

Using RDG160KN

• 2-stage heated or cooled with compressors

Using RDG160KN

Product no.	Control outputs	Fan
RDG160KN	On/off	Disabled, DC 0...10 V

- Key
- Y1 Heating or heating / cooling valve actuator
  - Y2 Cooling valve actuator
  - YE Electric heater
  - M1 1-speed or 3-speed fan
  - B1 Return air temperature sensor or external room temperature sensor (optional)
  - B2 Changeover sensor (optional)

- Notes**
- RDG100KN**
- Use P46 / P47 to change output from On / Off (factory setting) to PWM
  - Use DIP switches 4 and 5 to change output from ON/OFF to 3-position
- RDG160KN**
- Use P46 / P47 to change valve actuator output from DC (factory setting) to On / Off
  - Use DIP switch 4 to change fan output from DC (factory setting) to 3-speed

## Type summary









Product no.	Stock no.	Features							
		Operating voltage	Number of control outputs				Fan		Backlit LCD
			On/Off	PWM	3-pos.	DC	3-stage	DC	
RDG100KN	S55770-T163	AC 230 V	3 <sup>1)</sup>	2 <sup>1)</sup>	2 <sup>1)</sup>		✓		✓
RDG160KN	S55770-T297	AC 24 V	2 <sup>2)</sup>			2 <sup>2)</sup>		✓	✓
						2 <sup>2)</sup>	✓ <sup>3)</sup>		

1) Selectable: On/Off, PWM or 3-position (triac outputs)

2) Either On/Off or DC control signal





3) 3-speed fan selectable only with DC outputs

## Equipment combinations

	Description		Product no.	Data sheet
	Cable temperature sensor		QAH11.1	1840
	Room temperature sensor		QAA32	1747
	Condensation detector / extension module		QXA2000 / QXA2001 / AQX2000	1542
On / off actuators	Electromotoric ON/OFF actuator		SFA21...	4863
	Electromotoric ON/OFF valve and actuator (only available in AP, UAE, SA and IN)		MVI... / MXI...	4867
	Zone valve actuator (only available in AP, UAE, SA and IN)		SUA...	4832
On / off and PWM actuators *)	Thermal actuator (for radiator valves)		STA23... STA21... **)	4884 4893 **)
	Thermal actuator (for small valves 2.5 mm)		STP23... STP21... **)	4884 4893 **)

\*) With PWM control, it is not possible to ensure exact parallel running of more than one thermal actuator. If several fan-coil systems are controlled by the same room thermostat, preference should be given to motorized actuators with ON/OFF or 3-position control.

\*\*\*) Not sold any more

3-position actuators	Electrical actuator, 3-position (for radiator valves)		SSA31...	4893
	Electrical actuator, 3-position (for small valves 2.5 mm)		SSP31...	4864
	Electrical actuator, 3-position (for small valves 5.5 mm)		SSB31...	4891
	Electrical actuator, 3-position (for small valve 5,5 mm)		SSD31...	4861
	Electromotoric actuator, 3-position (for valves 5.5 mm)		SQS35...	4573

## Accessories

---

Description	Product no. / stock no.	Data sheet
KNX Power supply 160 mA (Siemens BT LV)	<b>5WG1 125-1AB02</b>	--
KNX Power supply 320 mA (Siemens BT LV)	<b>5WG1 125-1AB12</b>	--
KNX Power supply 640 mA (Siemens BT LV)	<b>5WG1 125-1AB22</b>	--

## Mechanical design

---

The room thermostat consists of 2 parts:

- Plastic housing with electronics, operating elements and room temperature sensor
- Mounting plate with the screw terminals

The housing engages in the mounting plate and is secured with 2 screws.

## Operation and settings

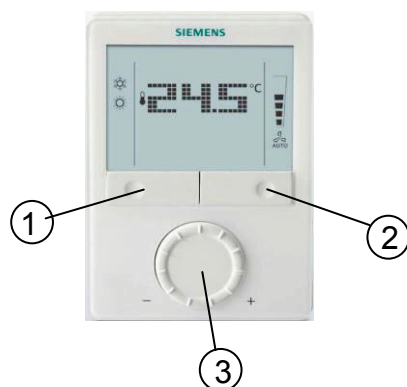

- 1) Operating mode button / Esc
- 2) Fan mode button / Ok
- 3) Rotary knob to adjust setpoints and parameters



## Display

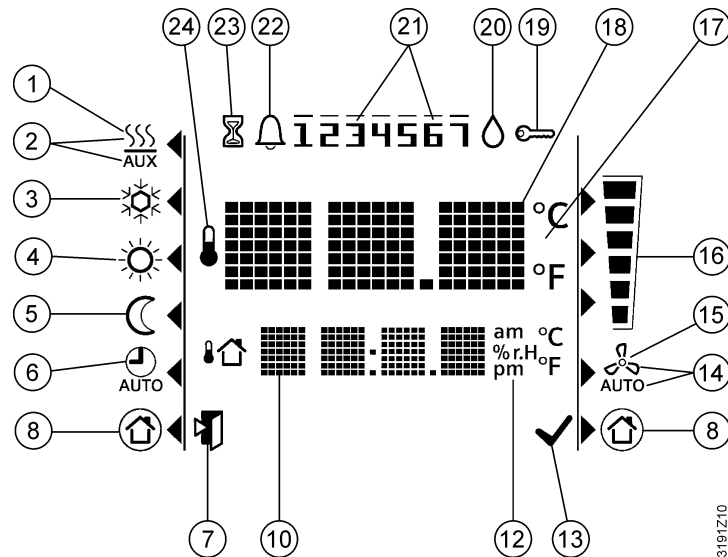

3191Z10

#	Symbol	Description	#	Symbol	Description	
1		Heating mode	14		Automatic fan	
2		Heating mode, electric heater active	15		Manual fan	
3		Cooling mode	16			Fan speed 1
4		Comfort				Fan speed 2
5		Economy				Fan speed 3
6		Auto Timer mode according to schedule (via KNX)	17		Degrees Celsius Degrees Fahrenheit	
8		Protection mode	18		Digits for room temperature and setpoint display	
9		Escape	19		Button lock	
10		Additional user information, like outdoor temperature  or time of day from KNX bus. Selectable via parameters	20		Condensation in room (dewpoint sensor active)	
12		Morning: 12-hour format Afternoon: 12-hour format	21		Weekday 1...7 from KNX bus 1 = Monday / 7 = Sunday	
13		Confirmation of parameters	22		Fault	
			23		Temporary timer function; visible when operating mode is temporarily extended (extended presence or absence)	
			24		Indicates that room temperature is displayed	

See the "Reference documentation", page 16 for information on how to engineer the KNX bus (topology, bus repeaters, etc.) and how to select and dimension connecting cables for supply voltage and field devices.

## Mounting and installation

Do not mount on a wall in niches or bookshelves, behind curtains, above or near heat sources, or exposed to direct solar radiation. Mount about 1.5 m above the floor.

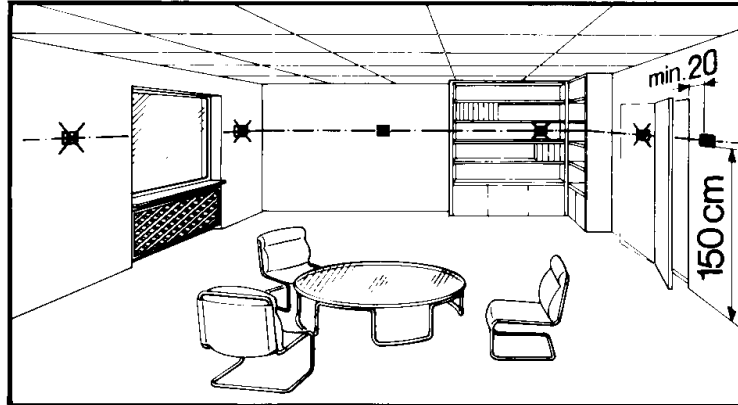

### Mounting



- Mount the room thermostat on a clean, dry indoor place without direct airflow from a heating / cooling device, and not exposed to drips or splash water.

### Wiring

See the mounting instructions M3191 enclosed with the thermostat.



- Comply with local regulations to wire, fuse and earth the thermostat.
- Properly size the cables to the thermostat, fan and valve actuators for AC 230 V mains voltage
- Use only valve actuators rated for AC 230 V
- The AC 230 V mains supply line must have an external fuse or circuit breaker with a rated current of no more than 10 A.
- Isolate the cables of input D1-GND for 230 V if the conduit box carries AC 230 V mains voltage.
- X1-M, X2-M or D1-GND: several switches (e.g. summer/winter switch) may be connected in parallel. Consider overall maximum contact sensing current for switch rating.
- Inputs X1-M and X2-M carry mains potential (RDG100KN only).  
Sensor cables must be suited for AC 230 V mains voltage
- Selectable relay function (RDG160KN): Follow instructions in P3191 to connect external equipment to the relay outputs.
- Isolate the cables of KNX communication input CE+ / CE- for 230 V if the conduit box carries AC 230 V mains voltage.
- No cables provided with a metal sheath.
- Disconnect from supply before removing from the mounting plate.

### Applications

The room thermostats are delivered with a fixed set of applications.

Select and activate the relevant application during commissioning using one of the following tools:

- Local DIP switch and HMI
- Synco ACS
- ETS

Set the DIP switches before snapping the thermostat to the mounting plate, if you want to select an application via **DIP switches**.

All DIP switches need to be set to “OFF” (“remote configuration”), if you want to select an application via **commissioning tool**.

After power is applied, the thermostat resets and all LCD segments flash, indicating that the reset was correct. After the reset, which takes about 3 seconds, the thermostat is ready for commissioning by qualified HVAC staff.

If all DIP switches are OFF, the display reads "NO APPL" to indicate that application commissioning via a tool is required.

**Note** Each time the application is changed, the thermostat reloads the factory setting for all control parameters, except for KNX device and zone addresses!

### Connect tool

Connect the Synco ACS or ETS tools to the KNX bus cable at any point for commissioning:

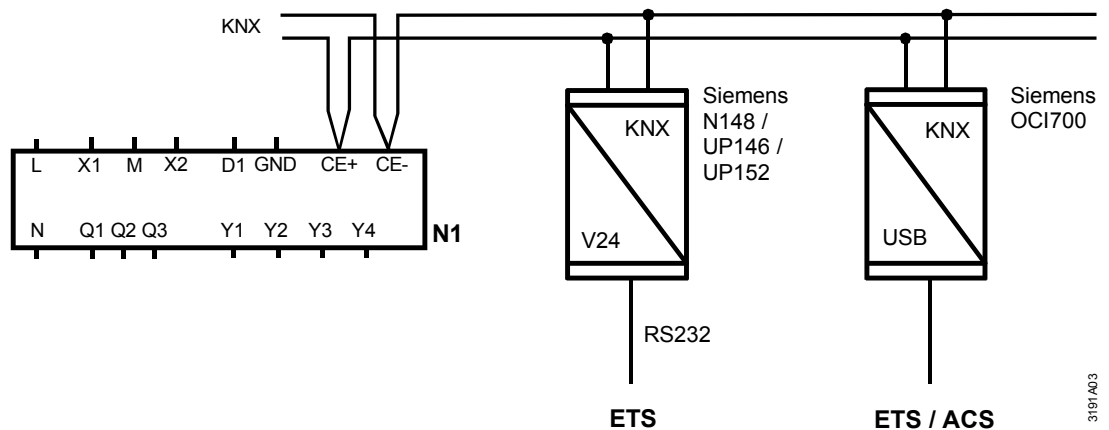

ACS and ETS require an interface:

- RS232 KNX interface (e.g. Siemens N148 / UP146 / UP152)
- OCI700 USB- KNX interface

**Note** An external KNX bus power supply is required if an RDG1...KN is connected directly to a tool (ACS or ETS) via KNX interface.

## Control parameters

The thermostat's control parameters can be set to ensure optimum performance of the entire system (see basic documentation P3191).

The parameters can be adjusted using

- Local HMI
- Synco ACS
- ETS

## Control sequence

- The control sequence may need to be set via parameter P01 depending on the application. The factory setting is as follows:

Application	Factory setting P01
2-pipe and chilled / heated ceiling, and 2-stage	1 = Cooling only
4-pipe, chilled ceiling and radiator	4 = Heating and cooling

## Calibrate sensor

- Recalibrate the temperature sensor if the room temperature displayed on the thermostat does not match the room temperature measured (after min. 1 hour of operation). To do this, change parameter P05.

## Setpoint and range limitation

- We recommend to review the setpoints and setpoint ranges (parameters P08...P12) and change them as needed to achieve maximum comfort and save energy.

## Programming mode

The programming mode helps identify the thermostat in the KNX network during commissioning.

Press the left and right buttons simultaneously for 6 sec to activate programming mode, which is indicated on the display with "PrO9".

Programming mode remains active until thermostat identification is complete.

## Assign KNX group addresses

Use ETS to assign the KNX group addresses of the RDG communication objects.

## KNX serial number

Each device has a unique KNX serial number inside the plastic housing.

An additional sticker with the same KNX serial number is enclosed in the packaging box. This sticker is intended for installers for documentation purposes.

## Disposal



This device is classified as waste electronic equipment under European Directive 2002/96/EC (WEEE) and may not be disposed of as unsorted municipal waste.

Adhere to all relevant national laws.

Regarding disposal, use the systems setup for collecting electronic waste.

Observe all local and applicable laws.

## Technical data

### RDG100KN

⚠ Power supply	Rated voltage	AC 230 V
	Frequency	50/60 Hz
	Power consumption	Max. 15 VA / 2 W
Outputs	Fan control	
	Q1, Q2, Q3 - N	AC 230 V, 5 mA...5(4) A
⛔ Note!	<b>Fans must NOT be connected in parallel!</b>	
	Connect one fan directly, for additional fans, one relay for each speed.	
Control outputs	Y1, Y2, Y3, Y4-N	Solid state (Triac) AC 230 V, 8mA...1 A
	Multifunctional inputs	
Inputs	X1-M / X2-M	
	Temperature sensor input	
	Type	QAH11.1 (NTC)
	Temperature range	0...49 °C
	Cable length	Max. 80 m
	Digital input	
	Operating action	Selectable (NO/NC)
	Contact sensing	DC 0...5 V, max. 5 mA
	Parallel connection of several thermostats for one switch	Max. 20 thermostats per switch. <b>Do not mix with D1!</b>
	Insulation against mains	N/A, mains potential ⚠
	D1-GND	
	Operating action	Selectable (NO/NC)
	Contact sensing	SELV DC 6...15 V, 3...6 mA
Parallel connection of several thermostats for one switch	Max. 20 thermostats per switch. <b>Do not mix with X1 / X2!</b>	
Insulation against mains	3.75 kV, reinforced insulation	
Function of inputs	Selectable	
External temperature sensor, heating/cooling changeover sensor, operating mode switchover contact, dewpoint monitor contact, enable electric heater contact, fault contact, monitoring input	X1: P38 X2: P40 D1: P42	

## RDG160KN

Power supply	Rated voltage	AC 24 V
	DC 24 V : Make sure to connect G to + and G0 to - DC 24 V	
	Frequency	50/60 Hz
	Power consumption	Max. 5 VA / 2 W
Outputs	ECM fan control Y50 - G0	SELV DC 0...10 V, Max. ±1 mA
	3-speed fan control, external equipment L - Q1 / Q2 / Q3 - N	AC 24...230 V, 5 mA...5(4) A
Inputs	<b>Fans must NOT be connected in parallel!</b>	
	Connect one fan directly, for additional fans, one relay for each speed.	
	Actuator control Y10 - G0 / Y20 - G0 (G)	SELV DC 0...10 V, Max. ±1 mA
	Multifunctional inputs X1-M / X2-M	SELV
	Temperature sensor input	
	Type	QAH11.1 (NTC)
	Temperature range	0...49 °C
	Cable length	Max. 80 m
	Digital input	
	Operating action	Selectable (NO/NC)
Contact sensing	DC 0...5 V, max. 5 mA	
Parallel connection of several thermostats for one switch	Max. 20 thermostats per switch	
D1-GND		
Operating action	Selectable (NO/NC)	
Contact sensing	DC 6...15 V, 3...6 mA	
Parallel connection of several thermostats for one switch	Max. 20 thermostats per switch.	
Function of inputs	Selectable	
External room temperature sensor, heating/cooling changeover sensor, operating mode switchover contact, dewpoint monitor contact, enable electric heater contact, fault contact, monitoring input, supply air temperature	X1: P38 X2: P40 D1: P42	



Note!

## RDG100KN, RDG160KN

KNX bus	Interface type	KNX, TP1-64 (electrically isolated)
	Bus current	20 mA
	Bus topology: See KNX manual (reference documentation, see below)	
Operational data	Switching differential, adjustable	
	Heating mode (P30)	2 K (0.5...6 K)
	Cooling mode (P31)	1 K (0.5...6 K)
	Setpoint setting and setpoint range	
	☀ Comfort mode (P08)	21 °C (5...40 °C)
	☺ Economy (P11-P12)	15 °C/30 °C (OFF, 5...40 °C)
	⬆ Protection (P65-P66)	8 °C/OFF (OFF, 5...40 °C)
	Multifunctional inputs X1 / X2 / D1	Selectable (0...8)
	Input X1 default value (P38)	1 (Ext. temperature sensor, room or return air)
	Input X2 default value (P40)	0 (no function)
Input D1 default value (P42)	3 (Operating mode switchover)	
Built-in room temperature sensor		
Measuring range	0...49 °C	
Accuracy at 25 °C	< ± 0.5 K	
Temperature calibration range	± 3.0 K	

Environmental conditions	Settings and display resolution	
	Setpoints	0.5 °C
	Current temperature value displayed	0.5 °C
	Operation	
	Climatic conditions	Class 3K5
	Temperature	0...50 °C
	Humidity	<95% r.h.
	Transport	
	Climatic conditions	Class 2K3
	Temperature	-25...60 °C
	Humidity	<95% r.h.
	Mechanical conditions	Class 2M2
	Storage	
	Climatic conditions	Class 1K3
Temperature	-25...60 °C	
Humidity	<95% r.h.	
Standards and directives	<b>CE</b> conformity	
	EMC directive	2004/108/EC
	Low-voltage directive	2006/95/EC
	<b>C</b> -tick conformity to EMC emission standard	AS/NZS 61000.6.3: 2007
	 Reduction of hazardous substances	2002/95/EC
	Product standards	
Automatic electrical controls for household and similar use	EN 60730-1	
Special requirements for temperature-dependent controls	EN 60730-2-9	
Electronic control type	2.B (micro-disconnection on operation)	
Home and Building Electronic Systems	EN 50090-2-2	
Electromagnetic compatibility		
Emissions (residential)	IEC/EN 61000-6-3	
Immunity (industrial and residential)	IEC/EN 61000-6-2	
Safety class	II as per EN 60730	
Pollution class	Normal	
Degree of protection of housing	IP30 as per EN 60529	
General	Connection terminals	
	Solid wires or stranded wires with wire end sleeves 1 x 0.4...2.5 mm <sup>2</sup> or 2 x 0.4...1.5 mm <sup>2</sup>	
	Housing front color	
	RAL 9003 white	
Weight without / with packaging		RDG100KN 0.270 kg / 0.380 kg RDG160KN 0.240 kg / 0.320 kg

<b>Reference documentation</b>	Handbook for Home and Building Control - Basic Principles ( <a href="http://www.knx.org/uk/news-press/publications/publications/">www.knx.org/uk/news-press/publications/publications/</a> )
Synco	CE1P3127 Communication via the KNX bus for Synco 700, 900 and RXB/RXL Basic documentation
Desigo	CM1Y9775 Desigo RXB integration – S-mode CM1Y9776 Desigo RXB / RXL integration – individual addressing CM1Y9777 Third-party integration CM1Y9778 Synco integration CM1Y9779 Working with ETS

## Connection terminals

### RDG100KN

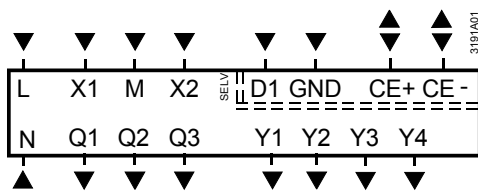

L, N	Operating voltage AC 230 V	(RDG100KN)
G, G0	Operating voltage AC 24 V	(RDG160KN)
L	Feed for relays AC 24...230 V	(RDG160KN)
X1, X2	Multifunctional input for temperature sensor (e.g. QAH11.1) or potential-free switch Factory setting: – X1 = External temperature sensor – X2 = No function (function can be selected via parameters P38 / P40).	
M	Measuring neutral for sensors and switches	

### RDG160KN

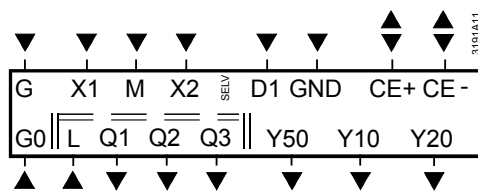

M	Measuring neutral for sensors and switches	
D1, GND	Multifunctional input for potential-free switch Factory setting: Operating mode switchover contact (function can be selected via parameter P42).	
Q1	Control output fan speed "low" AC 230 V	
Q2	Control output fan speed "medium" AC 230 V	
Q3	Control output fan speed "high" AC 230 V	
Q1...Q3	Also for special functions AC 24...230 V (RDG160KN)	
Y1...Y4	Control outputs "Valve" AC 230 V (RDG100KN) ("N/O" triac, for normally closed valves), output for electric heater via external relay	
Y10, Y20	Control outputs "Valve" DC 0...10 V (RDG160KN)	
Y50	Control output "Fan" DC 0...10 V (RDG160KN)	
CE+	KNX data +	
CE-	KNX data -	



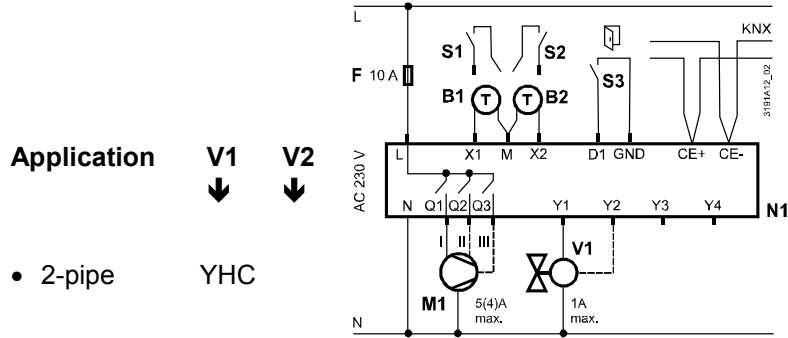

**Application**      **V1**    **V2**  
                               ↓        ↓

- 2-pipe                    YHC

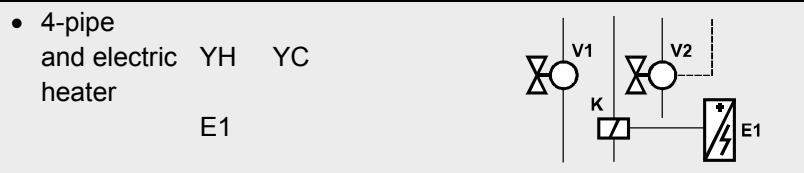
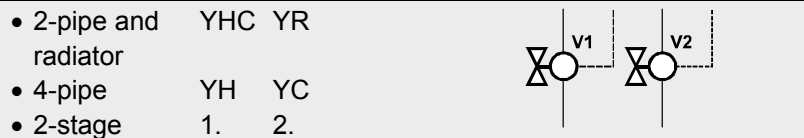

- |        |                                                                                                         |        |                                                                                                                         |
|--------|---------------------------------------------------------------------------------------------------------|--------|-------------------------------------------------------------------------------------------------------------------------|
| N1     | Room thermostat RDG100KN                                                                                | M1     | 1- or 3-speed fan                                                                                                       |
| F      | External fuse                                                                                           | V1, V2 | Valve actuators:<br>On/Off or PWM, 3-position,<br>heating, cooling, radiator, heating /<br>cooling,<br>1st or 2nd stage |
| S1, S2 | Switch (keycard, window contact,<br>presence detector, etc.)                                            | E1     | Electric heater                                                                                                         |
| S3     | Switch at SELV input<br>(keycard, window contact)                                                       | K      | Relay                                                                                                                   |
| B1, B2 | Temperature sensor (return air tempe-<br>rature, external room temperature,<br>changeover sensor, etc.) | YH     | Heating valve actuator                                                                                                  |
| CE+    | KNX data +                                                                                              | YC     | Cooling valve actuator                                                                                                  |
| CE-    | KNX data -                                                                                              | YHC    | Heating / cooling valve actuator                                                                                        |
|        |                                                                                                         | YR     | Radiator valve actuator                                                                                                 |
|        |                                                                                                         | E1     | Electric heater with relay / contactor Y<br>1 <sup>st</sup> / 2 <sup>nd</sup> 1 <sup>st</sup> / 2 <sup>nd</sup> stage   |

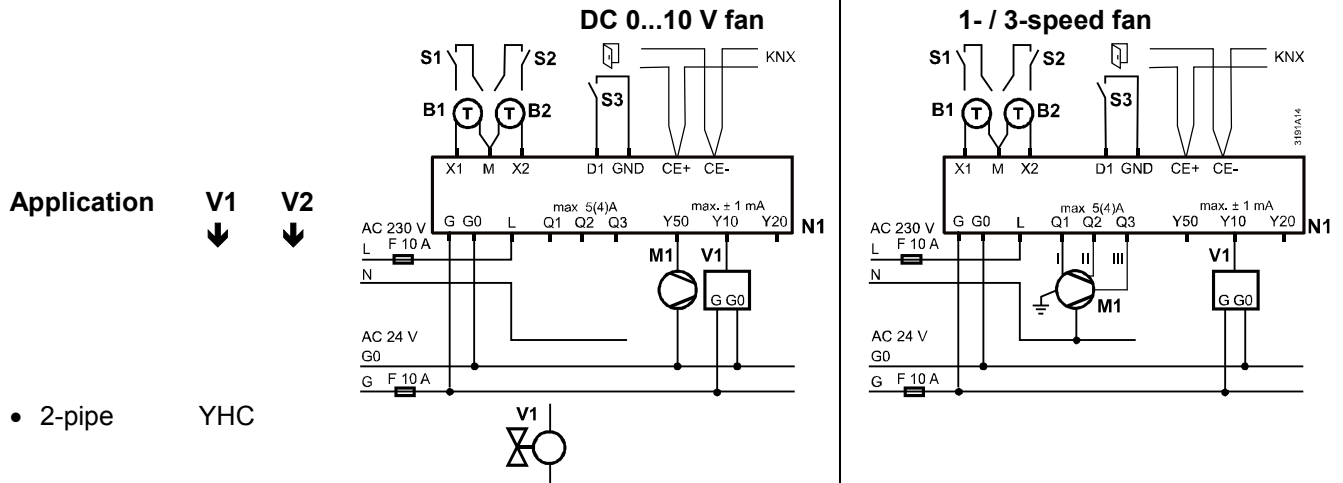

**Application**    **V1**    **V2**  
 ↓                    ↓                    ↓  
 • 2-pipe            YHC

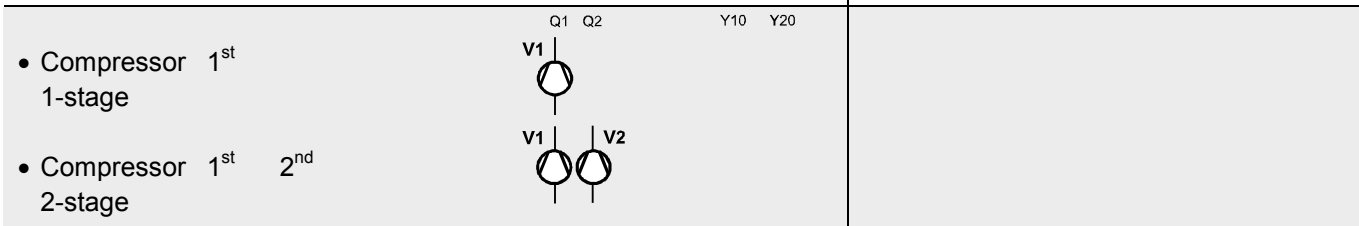
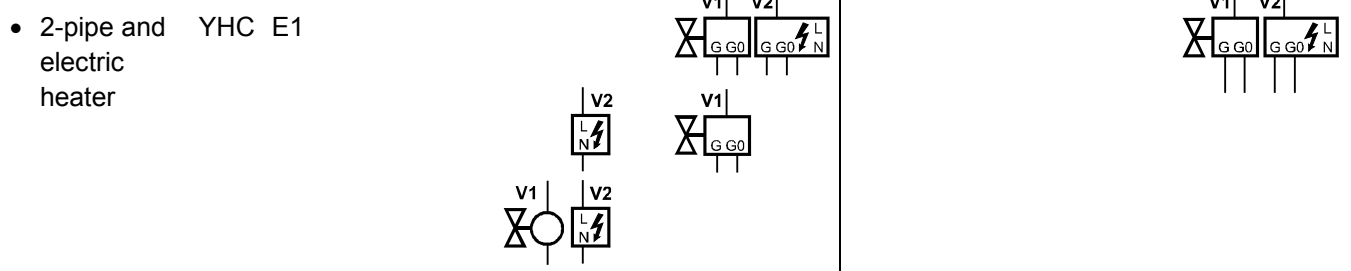
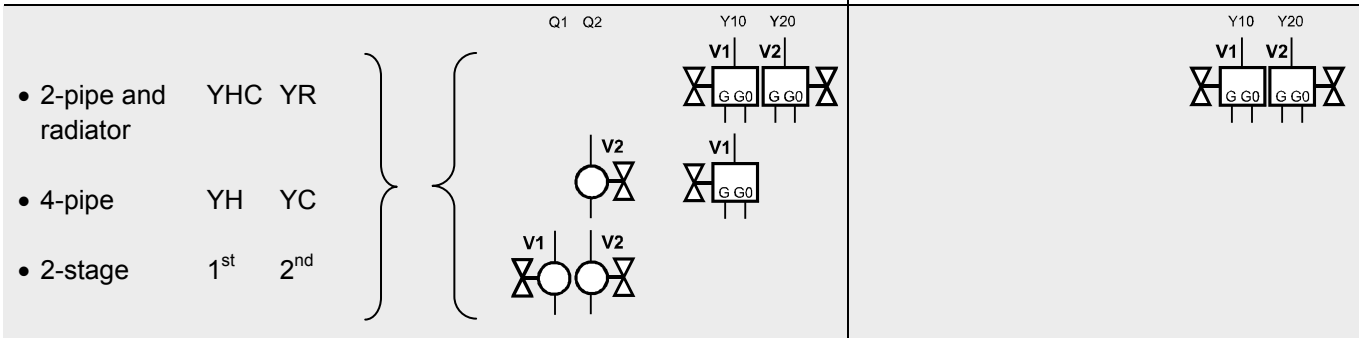

- N1    Room thermostat RDG160KN
- F     External fuse
- S1...S3 Switch (keycard, window contact, presence detector, etc.)
- B1, B2 Temperature sensor (return air temperature, external room temperature, changeover sensor, etc.)
- CE+    KNX data +
- CE-    KNX data -
- M1    1- or 3-speed fan, DC 0...10 V fan
- V1, V2 Valve actuators:  
 On/Off or PWM, 3-position, DC 0...10 V,  
 heating, cooling, radiator,  
 heating / cooling,  
 1st or 2nd stage
- YH    Heating valve actuator
- YC    Cooling valve actuator
- YHC   Heating / cooling valve actuator
- YR    Radiator valve actuator
- 1<sup>st</sup> / 2<sup>nd</sup> 1<sup>st</sup> / 2<sup>nd</sup> stage

## Dimensions

Dimensions in mm

