



## 24-hour room temperature controller REV13..

Heating applications

---

- Mains-independent, battery-operated room temperature controller featuring user-friendly operation, easy-to-read display and large numbers
- Self-learning two-position controller with PID response (patented)
- Operating mode selection:
  - Automatic mode with two heating phases
  - Automatic mode with one heating phase
  - Continuous comfort mode
  - Continuous energy saving mode
  - Frost protection
- Automatic modes with time switch program
- Heating zone control

### Use

---

Room temperature control in:

- Single-family and vacation homes.
- Apartments and offices.
- Individual rooms and professional office facilities.
- Commercially used spaces.

Control for the following equipment:

- Magnetic valves of an instantaneous water heater.
- Magnetic valves of an atmospheric gas burner.
- Forced draught gas and oil burners.
- Electrothermal actuators.
- Circulating pumps in heating systems.
- Electric direct heating.
- Fans of electric storage heaters.
- Zone valves (normally open and normally closed).

## Function

- PID control with self-learning or selectable switching cycle time
- 2-point control
- 24-hour time switch
- Remote control
- Preselected 24-hour operating modes
- Override function
- Party mode
- Frost protection mode
- Information level to check settings
- Reset function
- Sensor calibration
- Minimum limitation of setpoint
- Synchronization to radio time signal from Frankfurt, Germany (REV13DC)

## Type summary

24-hour room temperature controller

REV13

24-hour room temperature controller with receiver for time signal from Frankfurt, Germany (DCF77)

REV13DC

## Ordering

Please indicate the type number as per the "Type summary" when ordering.

## Delivery

The controller is supplied with batteries.

## Mechanical design









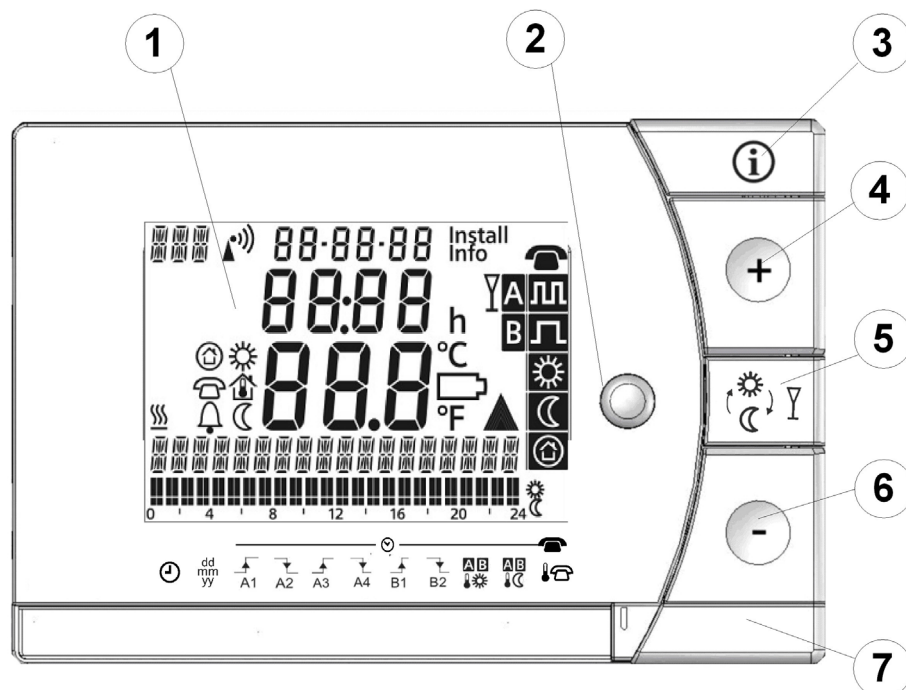











Plastic casing with an easy-to-read display and large numbers, easily accessible operating elements, and removable base.

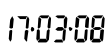

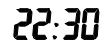

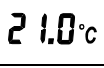
The housing contains the controller's electronics, DIP switches, and the relay with potential-free changeover contact. The easily accessible battery compartment allows for easy exchange of two 1.5 V alkaline batteries, type AAA.

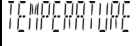
The base with terminal block provides lots of space to connect the wires.

## Display and operating elements





<b>1</b>		<b>Display</b>		
	Weekday (max. 3 spaces)		24 hour timeframe Switching pattern with flashing time cursor	
	Heating mode			
	Time signal from Frankfurt	<b>Info</b>	Information display	
Without language selection		Setpoint for frost protection mode	<b>h</b>	Time unit
		Setpoint for comfort mode	°C / °F	Temperature unit °C or °F
		Setpoint for remote control		Change battery
		Room temperature	<b>Y</b>	Party mode active
		Alarm		Heating / pump on
		Setpoint for energy saving mode		Remote control active
	17-03-08 Date (day - month - year)		Operating mode  (operating mode selector, see below)	
	22:30 Time of day			
	21.0°C Room temperature (measured)			
	TEMPERATURE Clear text display line (max. 18 spaces)			
				

<b>2</b>		<b>Operating mode selector</b>	
	Automatic 24-hour mode with two heating phases		
	Automatic 24-hour mode with one heating phase		
	Continuous comfort mode (= continuous comfort temperature)		
	Continuous energy saving mode (= continuous energy saving temperature)		
	Frost protection mode (= continuous frost protection temperature)		









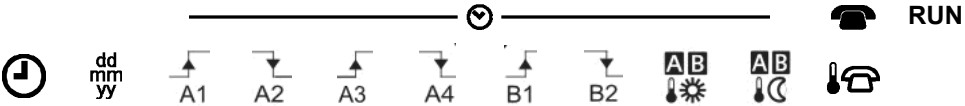

<b>3</b>		<b>INFO</b>	
	<p>Pressing the Info button once illuminates the display. Illumination automatically turns off after a short period of time.</p> <p>Pressing the Info button again activates the information display: <b>Info</b> is lit. The unit first displays queued error messages followed by important information (e.g. time switch programs, etc.).</p>		

<b>4</b>		<b>Plus button</b>	
	Increase values, set time, or make a selection.		

<b>5</b>	<b>Override button / party mode</b>
	In the time switch program, this button allows you to quickly change from the active temperature level to the next and back. Thus, you can quickly change to energy saving temperature when you leave the apartment for a short period of time, thus saving energy. The display indicates the change. It is valid only until the next switching time.
	<b>Activate party mode: Press the button for 3 seconds.</b>
	Party mode is available only in operating modes <b>A</b> and <b>A</b> . In party mode, the controller controls to a freely selectable temperature for a freely selectable period of time. In party mode, symbol <b>Y</b> is displayed along with the end of party mode.

<b>6</b>	<b>Minus button</b>
	Decrease values, set time, or make a selection.

<b>7</b>	<b>Program selection slider</b>
	

	Time.
<b>dd mm yy</b>	Day – Month – Year (2 spaces for day, month, and year).
 A1	Start time 1
 A2	End 1
 A3	Start time 2
 A4	End 2
 B1	Start time
 B2	End
	Comfort temperature for the automatic mode time switches A and B.
	Energy saving temperature for the automatic mode time switches A and B.
	Temperature setpoint at active remote control.
<b>RUN</b>	Slider position RUN allows for closing the cover.

## Operating modes

### 24-hour operation with time switch program

Example A with 2 heating phases

The controller offers the two time switch programs **A** and **B**.

Enter a start time and end time for each heating phase. The comfort temperature setpoint can be freely entered and is the same for both heating phases. Between the heating phases the controller always switches to the same, freely selectable energy saving temperature setpoint.

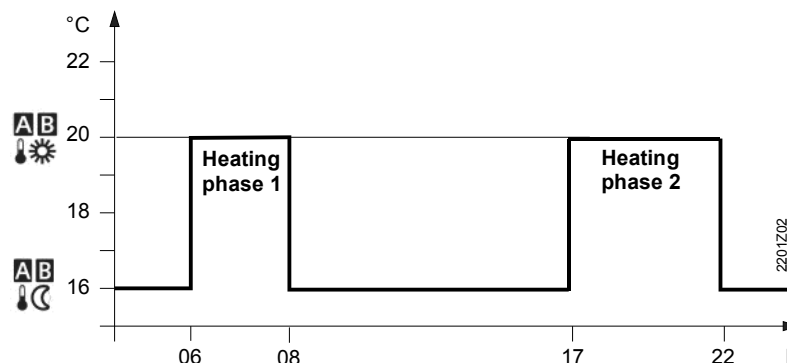

### Continuous operating modes

The controller also offers the three continuous modes: comfort mode, energy saving mode and frost protection mode.

### Setpoints

You can freely adjust temperature setpoints.

Setting range for all setpoints without setpoint limitation 3...35 °C.

Setting range for all setpoints with setpoint limitation 16...35 °C.

### Factory setting

Factory settings: Heating		
	<b>A</b> 	20 °C
	<b>A</b> 	16 °C
		8 °C
		12 °C

Factory settings: Switching times				
<b>A</b>	A1	A2	A3	A4
	06:00	08:00	17:00	22:00
<b>B</b>	B1	B2		
	07:00	23:00		

## Remote control

Use a suitable remote control unit to activate the "Remote control"  temperature setpoint in the controller. Changeover takes place by making a **potential-free contact** connected to terminals T1 and T2.

A flashing  symbol indicates active remote control mode.

After the contact opens, the previously set operating mode is reactivated.

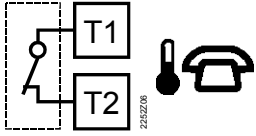
Operation according to controller setting	Temperature setpoint "remote control" active
	

Suitable remote control units are:



Telephone modem, manual switch, window contact, presence detector, central unit, etc.

### Enter temperature for active remote control

You can freely select the temperature for active remote control. Activating remote control immediately enables control to the remote control temperature regardless of the currently active operating mode. When you deactivate remote control, the controller returns to the set operating mode.



A flashing  symbol indicates active remote control mode.



**Proceed as follows to enter your settings:**

	Set slider to temperature for active remote control: Press  or  to set the desired temperature.
<b>RUN</b>	Return the slider to position <b>RUN</b> .

## Technical features

### DIP switches

△ ON / ▽ OFF		1	2	3	4	5	6
See <b>A</b>	Sensor calibration On	△					
	Sensor calibration Off	▽					
<b>B</b>	Setpoint limitation 16...35 °C		△				
	Setpoint limitation 3...35 °C		▽				
<b>C</b>	Temperature display °F			△			
	Temperature display °C			▽			
<b>D</b>	PID self-learning				△	△	
	PID 6				△	▽	
	PID12				▽	△	
	2-point				▽	▽	
<b>E</b>	Quartz						△
	 Radio clock						▽
<b>F</b>	DIP switch reset 	After you change one or several DIP switch positions, you must press the DIP switch reset button to reset the DIP switch. <b>Otherwise, the previous setting remains active!</b>					
<b>Factory setting: All DIP switches to ▽ OFF</b>							

- A Sensor calibration:** DIP switch 1
- If the displayed room temperature does not match the measured room temperature, the temperature sensor can be recalibrated.
- Set DIP switch to ON and press the DIP switch reset button:  
**CAL** symbol is displayed. The currently measured temperature flashes.  
 Press  or  to recalibrate by max.  $\pm 5\text{ }^{\circ}\text{C}$ .  
 Set DIP switch to OFF and press the DIP switch reset button to save the settings.
- B Setpoint limitation:** DIP switch 2
- The minimum setpoint limitation of  $16\text{ }^{\circ}\text{C}$  prevents undesired heat transfer to neighboring spaces in buildings featuring several heating zones.
- DIP switch ON: Setpoint limitation **16...35 °C**.  
 DIP switch OFF: Setpoint limitation **3...35 °C** (factory setting).  
 Press the DIP switch reset button to save the settings.
- C Temperature display in °C or °F:** DIP switch 3
- DIP switch ON: Temperature display in **°F**.  
 DIP switch OFF: Temperature display in **°C** (factory setting).  
 Press the DIP switch reset button to save the settings.
- D Control behavior:** DIP switches 4 and 5
- The REV13... is a two-position controller with PID control. The room temperature is controlled through cyclic switching of an actuating unit.
- DIP switches 4 ON and 5 ON: **PID self-learning**  
 Adaptive control for all applications.
- DIP switches 4 ON and 5 OFF: **PID 6**  
 Fast controlled system for applications in locations with large temperature deviations.
- DIP switches 4 OFF and 5 ON: **PID 12**  
 Normal controlled system for applications in locations with normal temperature deviations.
- DIP switches 4 OFF and 5 OFF: **2-point**  
 For complex controlled systems, simple two-position controller with  $0.5\text{ }^{\circ}\text{C}$  switching differential (factory setting).  
 Press the DIP switch reset button to save the settings.
- E Radio clock:** DIP switch 10
- Only applicable to REV..DC (with integrated DCF77 receiver to receive time signal from Frankfurt, Germany)!
- DIP switch ON: Clock run by controller-internal quartz.  
 DIP switch OFF:  Time signal DCF77 from Frankfurt, Germany.  
 Press the DIP switch reset button to save the settings.
- Note on synchronization**
- During startup, REV..DC synchronizes automatically to the time signal (DCF77) from Frankfurt, Germany. Synchronization takes max. 10 minutes. Synchronization restarts each time you press the button or move the program selection slider from the RUN position during these 10 minutes. Siemens recommends to set the desired settings upon startup, install the REV..DC in the desired location, and not carry out any actions on the REV..DC for the next 10 minutes.
- Note on reception**
- In normal operation, the REV..DC synchronizes to the radio clock every day at 3:10 a.m. The time signal from Frankfurt is modulated to a radio signal. The reception of this radio signal depends on the distance to Frankfurt, atmospheric conditions as well as the location where the REV..DC is installed. Siemens cannot guarantee that the REV..DC can receive the time signal from Frankfurt at any time and any place.
- No reception**
- The radio clock symbol is deactivated and an error message is displayed if the clock was not able to synchronize the time for 7 consecutive days. The controller then runs on the internal quartz.
- F DIP switch reset**
- After you change one or several DIP switch positions, you must press the DIP switch reset button to reset the DIP switch. Otherwise, the previous setting remains active!



## Access to the expert level

---

Set the program selection slider to RUN. Press and simultaneously for 3 seconds, release the buttons, and within 3 seconds press and hold down and simultaneously for 3 seconds, release , and press for another 3 seconds. This releases the engineering settings. **Install** is displayed.

The display first shows language selection with Code 00. Press the buttons or to navigate the settings.

Confirm settings by pressing .

Press the operating mode selector to exit the engineering settings.

### Code list

Function block	Code	Name	Factory setting	Your setting
Basic settings	00	Language	English	
	01	Sensor calibration	off	
	02	Switching differential 2-point	0.5 °C	
LCD optimization	10	Illumination time	10 seconds	
	11	Background brightness	0	
	12	Contrast	0	
Clock settings	30	Time zone Deviation from time signal in Frankfurt (Central European Time CET) (see Note 1)	0 hours	
	31	Start of daylight saving time (see Note 2)	March 31 (03-31)	
	32	End of daylight saving time (see Note 3)	October 31 (10-31)	

Note 1: This entry has no effect if the radio clock either is inactive or not available.  
The time signal received from Frankfurt is shifted by the value set in Code 30 (time zone) if the radio clock is active.

Note 2: The time is always changed over at 2 a.m. on the Sunday preceding the set date if there is no radio clock or if it is inactive. The time change is shifted by the value set in Code 30 (time zone) when the radio clock is active.

Note 3: The time is always changed over at 3 a.m. on the Sunday preceding the set date if there is no radio clock or if it is inactive.

### Functional check

---

- Check the display. If there is no display, check insertion and function of the batteries.
- Operating mode "Continuous comfort mode" read displayed temperature.
- Set the temperature setpoint higher than the displayed room temperature (see operating instructions).
- The relay and, as a result, the actuating device must switch at the latest after one minute. Symbol is displayed. If not displayed:
  - Check actuating device and wiring.
  - It is possible that in heating mode the room temperature is higher than the set temperature setpoint.
- Set the temperature setpoint for operating mode "Continuous comfort mode" to the desired value.
- Select the desired operating mode.



### User-defined settings:



,  and  simultaneously for 3 seconds:

This resets all temperature and time settings of the program selection slider to default values (see also "Factory settings" in the operating instructions). The expert settings remain unchanged.

The clock starts at 12 p.m., the date on 01-01-08 (01 - January - 2008).

During the reset, all display fields are lit and can be checked accordingly.

### All user-defined settings plus expert settings:

Press the DIP switch reset button ,  and  simultaneously for 5 seconds:

After the reset, **all factor settings** are reloaded. This applies to the program selection slider as well as to the expert settings.

## Engineering

---

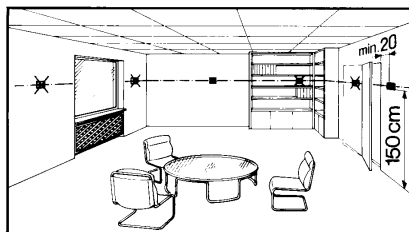

- Mount the room temperature controller in the main living room.
- Select the mounting place so that the sensor can acquire the air temperature in the room as accurately as possible and without being influenced by solar radiation or other heat or refrigeration sources.
- Mounting height is approx. 1.5 m above the floor.
- You can mount the unit on most commercially available recessed conduit boxes or directly on the wall.



### Mounting and installation

- Begin installation by first attaching and wiring the base. You can mount the base on most commercially available recessed conduit boxes or directly on the wall. Then insert the controller from top to bottom into the base. For more information, see the installation instructions supplied with the unit.
- Comply with all local regulations on electrical installation.
- Wire separately the remote control contact T1 / T2 using a separate, shielded cable.

### Commissioning

- Remove from the batteries the battery transit tab designed to prevent premature activation of the unit: Select desired language by  or . Confirm by .
- You can change the control characteristics using the DIP switch on the rear of the unit.
- Set any thermostatic radiator valves to their fully open position, if present in the reference room.
- Recalibrate the temperature sensor (see "Sensor calibration") if the displayed room temperature does not match the room temperature measured.

### Notes

This is a software class A controller designed for use at a normal degree of pollution.

## Technical data

General unit data	Power	DC 3 V
	Batteries (alkaline AAA)	2 x 1,5 V
	Life	Ca. 2 years
	Backup of clock when changing battery (all other data remain in EEPROM)	Max. 1 min
	Switching capacity of relay	
	Voltage	AC 24...250 V
	Current	0.1...6 (2.5) A
	Protection class	II as per EN 60 730-1
	Sensing element	NTC 10 k $\Omega$ $\pm$ 1 % at 25 °C
	Measuring range	0...50 °C
	Time constant	Max. 10 min
	Setpoint setting ranges	
	All temperature settings	3...35 °C
	Resolution for settings and displays	
	Setpoints	0.2 °C
Switching times	10 min	
Actual value measurement	0.1 °C	
Actual value display	0.2 °C	
Time display	1 min	
Standards	CE conformity	
	Electromagnetic compatibility	2004/108/EEC
	Low voltage directive	2006/95/EC
C-tick	 N474	
Product safety	Automatic electrical controls for household and similar use	EN 60 730-1
	Electromagnetic compatibility	
	Immunity	EN 61000-6-2
	Emissions	EN 61000-6-3
Environmental conditions	Degree of protection	IP20
	Operation	
	Climatic conditions	3K3 as per IEC 60 721-3
	Temperature	5...40 °C
	Humidity	< 85 % r.h.
	Storage and transport	
	Climatic conditions	2K3 as per IEC 60 721-3
Temperature	-25...70 °C	
Humidity	< 93 % r.h.	
	Mechanical conditions	2M2 as per IEC 60 721-3
Weight	Excl. packaging	0.24 kg
Color	Housing	RAL9003 signal white
	Base	RAL7038 gray
Size	Housing with base	94 x 130 x 30 mm

## Connection diagrams

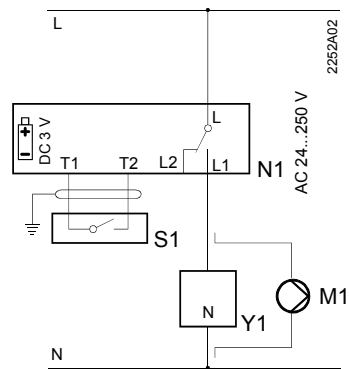

### REV13 / REV13DC

L Phase, AC 24 ... 250 V  
 L1 N.O. contact,  
 AC 24 ...250 V / 6 (2.5) A  
 L2 N.C. contact,  
 AC 24 ... 250 V / 6 (2.5) A  
 M1 Circulating pump  
 N1 REV13... controller

S1 Remote control unit (potential-free)  
 T1 Remote control signal  
 T2 Remote control signal  
 Y1 Actuating device

## Application examples

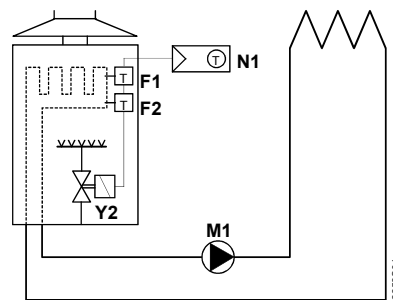

Instantaneous water heater

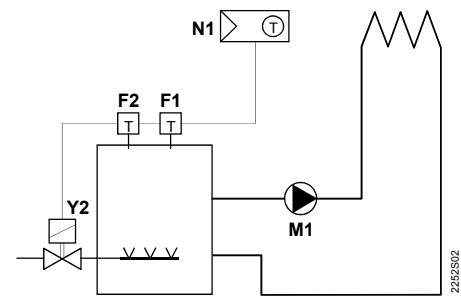

Atmospheric gas burner

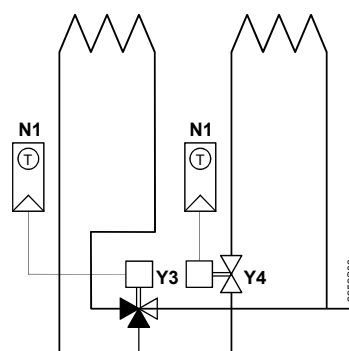

Zone valve

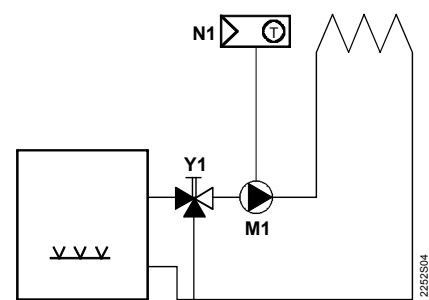

Circulating pump with precontrol by manual mixing valve

F1 Thermal reset limit thermostat  
 F2 Manual reset safety limit thermostat  
 M1 Circulating pump  
 N1 REV13.. room temperature controller  
 Y1 3-port valve with manual adjustment  
 Y2 Magnetic valve  
 Y3 Three-port valve with actuator  
 Y4 Two-port valve with actuator

## Dimensions

