



## Heating Controller

## RVL482

including d.h.w. heating

---

**Multifunctional and communicating heating controller for use in residential and non-residential buildings. Suited for heating circuit control with demand-compensated boiler temperature control or precontrol. Suited for modulating or 2-stage burners. Control of d.h.w. heating. 21 programmed plant types. Operating voltage AC 230 V**

### Use

- Types of houses and buildings:
  - Multifamily houses
  - Single-family houses
  - Non-residential buildings
- Types of plants:
  - Heating zones including d.h.w. heating with own heat source
  - Interconnected plants consisting of heat source, several heating zones and central or decentral d.h.w. heating plant
- Types of heating systems:
  - Radiator, convector, underfloor and ceiling heating systems, or radiant panels

### Functions

#### Heating zone control

- Weather-compensated flow temperature control through control of the mixing valve in one of the heating zones
- Weather-compensated flow temperature control through control of the mixing valve and demand-compensated control of the boiler temperature through control of the burner in one of the heating zones
- Weather-compensated flow temperature control through control of the mixing valve and demand-compensated control of the boiler temperature through control of the burner in one of the heating zones; with separate mixing valve for minimum limitation of the boiler return temperature







## Precontrol

- Demand-compensated control of the boiler temperature through control of the burner; heat demand signal via data bus
- Demand-compensated control of the boiler temperature through control of the burner; heat demand signal via data bus; with separate mixing valve for minimum limitation of the boiler return temperature

## D.h.w. heating

- D.h.w. heating:
  - Through control of the charging pump
  - Through control of the mixing valve
  - Via heat exchanger through control of the valve in the primary return
  - Via solar collector
- Control of a circulating pump and of an electric immersion heater

## Operating modes

- Auto  **Automatic mode**  
Automatic changeover from the NORMAL to the REDUCED room temperature, and vice versa, according to the 7-day program, automatic changeover to holiday mode, demand-compensated control of the heating system (ECO function)
-  **Setback mode**  
Continuous heating to the REDUCED temperature (with ECO function)
-  **Comfort mode**  
Continuous heating to the NORMAL temperature (without ECO function)
-  **Protection**
-  **Automatic d.h.w. heating**
-  **Manual operation**  
No control, circulating pumps in service

Frost protection is ensured in all operating modes.

## Other functions

- Optimization functions
- Protective functions
- Remote control
- Commissioning tools
- Communication functions

## Ordering

When ordering, please give type reference **RVL482**.

The controller is supplied complete with Operating Instructions and Installation Instructions.

Sensors and, if required, room unit, actuator and valve must be ordered as separate items.

## Product documentation

<i>Type of documentation</i>	<i>Document no.</i>	<i>Part no.</i>
Basic Documentation	P2542	–
Installation Instructions (languages: de, en, fr, nl, sv, fi, da, it, es)	G2542	74 319 0619 0
Operating Instructions (languages: de, en, fr, nl, sv, fi, da, it, es)	B2540	74 319 0616 0
CE Declaration of Conformity	T2540	–
Environmental Declaration	E2542	–

## Equipment combinations

---

### Suitable sensors and room units

- Flow , return and d.h.w. temperature: All sensors with sensing elements LG-Ni 1000, for example:
  - Strap-on temperature sensor QAD22
  - Immersion temperature sensor QAE212... or QAP21.3
  - Collector temperature sensor (solar) QAP21.
- Room temperature:
  - Room unit QAW50 or QAW70
  - Room temperature sensor QAA24
- Outdoor temperature:
  - Outside sensor QAC22 (LG-Ni 1000 sensing element)
  - Outside sensor QAC32 (NTC 575 sensing element)
  - Wind sensor (commercially available, DC 0...10 V)
  - Solar impact sensor QLS60

### Suitable actuators

All electromotoric and electrohydraulic actuators for 3-position control made by Siemens can be used.

### Communication

The controller can communicate with:

- All LPB-compatible devices made by Siemens
- The SYNERGYR OZW30 central unit (software version 3.0 or higher)

### Note

The heating controller RVL482 **cannot** be used as partner unit for the RVL469!

Plant types

Heating circuit plant types

<p><b>1</b></p> <p>Heating circuit control with mixing group</p> <p>Can be combined with d.h.w. types:</p> <ul style="list-style-type: none"> <li>- with types 1, 2 and 3 via hydraulic connection at ○ and □</li> <li>- with type 4 without hydraulic connection</li> </ul>	
<p><b>2</b></p> <p>Heating circuit control with mixing group, boiler control</p> <p>Can be combined with d.h.w. types:</p> <ul style="list-style-type: none"> <li>- with types 1, 2 and 3 via hydraulic connection at ○ and □</li> <li>- with type 4 without hydraulic connection</li> </ul>	
<p><b>3</b></p> <p>Heating circuit control with mixing group, boiler control, maintained boiler return temperature with mixing valve</p> <p>Can be combined with d.h.w. types:</p> <ul style="list-style-type: none"> <li>- with type 1 via hydraulic connection at ○ and □</li> <li>- with type 4 without hydraulic connection</li> </ul>	
<p><b>4</b></p> <p>Precontrol with boiler</p> <p>Can be combined with d.h.w. types:</p> <ul style="list-style-type: none"> <li>- with types 1, 2 and 3 via hydraulic connection at ○ and □</li> <li>- with type 4 without hydraulic connection</li> </ul>	
<p><b>5</b></p> <p>Precontrol with boiler, maintained boiler return temperature with mixing valve</p> <p>Can be combined with d.h.w. types:</p> <ul style="list-style-type: none"> <li>- with type 1 via hydraulic connection at ○ and □</li> <li>- with type 4 without hydraulic connection</li> </ul>	

D.h.w. circuit plant types

<p><b>0</b></p> <p>No d.h.w. heating</p>	
<p><b>1</b></p> <p>D.h.w. heating with charging pump (optional solar and/or electric immersion heater)</p> <p>Note:</p> <ul style="list-style-type: none"> <li>- Circulating pump M4 only with heating circuit types 1, 2 and 4</li> <li>- Electric immersion heater not possible with modulating burner</li> </ul>	

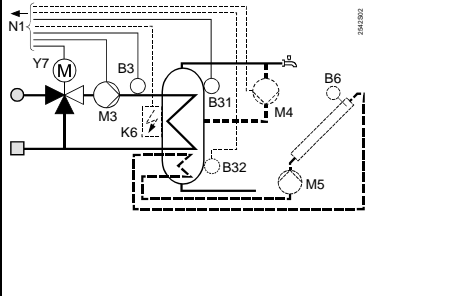
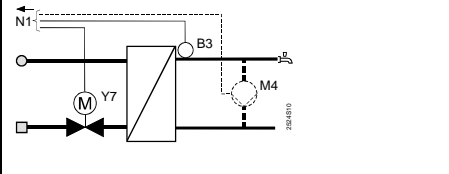
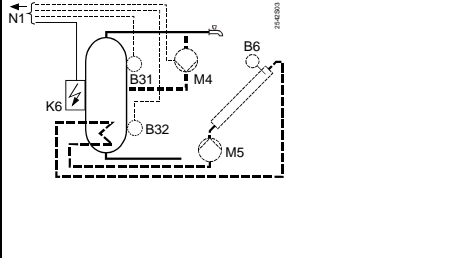
<p><b>2</b></p> <p>D.h.w. heating with mixing group (optional solar and/or electric immersion heater)</p> <p>Note:</p> <ul style="list-style-type: none"> <li>- Circulating pump M4 only with heating circuit types 1, 2 and 4</li> <li>- Electric immersion heater not possible with modulating burner</li> </ul>	
<p><b>3</b></p> <p>D.h.w. heating with heat exchanger</p> <p>Note:</p> <ul style="list-style-type: none"> <li>- Circulating pump M4 only with heating circuit types 1, 2 and 4</li> </ul>	
<p><b>4</b></p> <p>D.h.w. heating with electric immersion heater (optional solar heating)</p> <p>Note:</p> <ul style="list-style-type: none"> <li>- Circulating pump M4 only with heating circuit types 1, 2 and 4</li> <li>- Electric immersion heater not possible with modulating burner</li> </ul>	

A6 Room unit	LPB Data bus
B1 Flow sensor	K6 Electric immersion heater
B2 Boiler sensor	M1 Circulating pump / bypass pump
B3 Flow sensor for d.h.w.	M2 Heating circuit pump
B31 D.h.w. storage tank sensor / control thermostat 1	M3 Charging pump
B32 D.h.w. storage tank sensor / control thermostat 2	M4 Boiler pump / circulating pump
B5 Room sensor	M5 Collector pump
B6 Collector sensor	N1 Controller RVL482
B7 Return sensor	U1 Solar impact sensor
B9 Outside sensor	U2 Wind sensor
E1 Heat source (boiler)	Y1 Heating circuit mixing valve
E2 Load (space)	Y7 D.h.w. mixing or 2-port valve, or mixing valve for minimum limitation of the boiler return temperature

## Working principle

The RVL482 offers 5 different plant types for space heating and precontrol, and 4 plant types for d.h.w. heating all of which are ready programmed. By combining the different plant types, a total of 21 plants can be configured.

When commissioning the system, the appropriate plant types for space heating / pre-control and d.h.w. heating need to be entered. This activates all functions required for the respective type of plant. The default settings are practice-oriented.

All functions that are not required for the configured plant type will not be shown and are deactivated.

## Enduser settings

With weather-compensated control, the flow temperature is controlled via the heating curve as a function of the outdoor temperature. Its basic setting is made with the little bar on the front of the unit or on an operating line. The room temperature can be readjusted with the setting knob.

In addition, following can be entered by the enduser:

- The room temperature setpoints of NORMAL heating, REDUCED heating and frost protection / holidays
- The d.h.w. temperature setpoints
- 2 independent 7-day switching programs and a maximum of 8 holiday periods per year
- The operating mode
- The time of day and the date

<b>Temperature acquisition</b>	<ul style="list-style-type: none"> <li>• Flow temperature: with LG-Ni 1000 sensor</li> <li>• Outdoor temperature: with LG-Ni 1000 or NTC 575 sensor; the RVL482 automatically identifies the type of sensor used. In interconnected plants, it is also possible to identify the source of the outdoor temperature</li> <li>• Room temperature: With a room sensor or room unit, or both (averaging)</li> </ul>
<b>Space heating</b>	<ul style="list-style-type: none"> <li>• The room temperature is included in the control. It can be acquired with a sensor or can be simulated by a room model that uses an adjustable building time constant. When using a sensor, the impact on the control can be adjusted. It is also possible to limit the maximum room temperature</li> <li>• The influence of solar radiation and/or wind can be acquired by a solar impact and/or wind sensor, which is then included in the control. The authority of both is adjustable. In interconnected plants, the sensor signals can be provided from external locations via data bus</li> <li>• The heating is switched on and off depending on demand (ECO function). It is switched off when the amount of heat stored in the building structure is sufficient to maintain the required room temperature. In that case, the controller takes into account the progression of the room temperature and the building's heat storage capacity. It is possible to set 2 heating limits, one for NORMAL heating and one for REDUCED heating</li> <li>• The control is optimized. Switching on, heating up and shutting down are controlled such that, during occupancy times, the required room temperature is always maintained. At the end of each occupancy period, the heating will be shut down (circulating pump) until the room temperature setpoint for the nonoccupancy time is reached (quick setback, can be deactivated). During heating up, the room temperature setpoint can be raised (boost heating). It is possible to set maximum limits for the heating up time and for early shutdown</li> </ul>
<b>3-position control</b>	<p>3-position control operates as weather-compensated flow temperature control. P-band and integral action time are adjustable. The flow temperature is controlled via the controlling element (seat or slipper valve). Minimum and maximum limitation of the flow temperature as well as maximum limitation of the rate of setpoint rise are adjustable.</p>
<b>Boiler temperature control</b>	<p>Boiler temperature control is demand-compensated. If there is no demand for heat, the boiler will either be shut down or maintained at the minimum limit value (selectable). Minimum and maximum limitation of the boiler temperature are adjustable. With regard to the heat source, a differentiation is made between multistage and modulating burners. The type of heat source can be selected.</p>
Multistage burner	<p>In the case of a multistage burner, the boiler temperature is controlled through 2-position control. The boiler temperature is controlled by activating and deactivating the single- or 2-stage burner (direct burner control). 2-stage operation is enabled when the release limit of burner stage 2 is reached, and disabled when the reset limit of burner stage 2 is reached. The limits can be adjusted.</p>
Modulating burner	<p>In the case of a modulating burner, boiler temperature control is achieved through activation and deactivation of the burner and control of the burner's modulating actuator (PID mode). P-band, integral action time and derivative action time are adjustable. Modulation is activated during the second stage of the 2-stage burner.</p>

<b>Minimum limitation of the return temperature</b>	<p>Minimum limitation of the return temperature protects the boiler against flue gas condensation. With the RVL482, this function can be implemented in 3 different ways:</p> <ul style="list-style-type: none"> <li>• Lowering of the consumers' flow temperature setpoint</li> <li>• Use of a bypass pump (only with plant types 2-x and 4-x)</li> <li>• Own mixing valve in the boiler return (only with plant types 3-x and 5-x)</li> </ul>
<b>Maximum limitation of the return temperature</b>	<p>The RVL482 offers 2 types of return temperature maximum limitation:</p> <ul style="list-style-type: none"> <li>• With plant types 1-x: Limitation acts on the setpoint of the heating circuit's flow temperature</li> <li>• With plant types 2-x and 4-x: Limitation acts on the boiler temperature setpoint (suited for bivalent plants)</li> </ul>
<b>Locking functions</b>	<p>On the software side, all settings can be locked to prevent tampering.</p>
<b>Time switches</b>	<ul style="list-style-type: none"> <li>• The RVL482 has 3 independent 7-day time switches whose assignment can be selected. Each 7-day time switch affords 3 daily on periods, which may differ from one weekday to the other.</li> </ul> <p>The heating circuit, d.h.w. heating, circulating pump and multifunctional relay can be assigned to one of the three 7-day time switches</p> <ul style="list-style-type: none"> <li>• For entering a maximum of 8 holiday periods, the RVL482 is equipped with a yearly time switch featuring automatic summer-/wintertime changeover</li> </ul>
<b>D.h.w. heating</b>	<p>D.h.w. heating source can be</p> <ul style="list-style-type: none"> <li>• Boiler</li> <li>• Heat exchanger</li> <li>• Precontroller</li> <li>• Solar collector (charging is shown in the LCD with )</li> <li>• Electric immersion heater (summer operation)</li> </ul> <p>D.h.w. heating is controlled independent of the heating circuit. Charging to the NORMAL or REDUCED d.h.w. setpoint can be adjusted to meet individual needs. It can be released:</p> <ul style="list-style-type: none"> <li>• According to its own 7-day program</li> <li>• According to the switching program of the heating circuit (one hour before space heating starts)</li> <li>• According to the switching programs of the zone controllers on the data bus</li> <li>• Continuously (24 hours a day)</li> </ul> <p>D.h.w. heating features a legionella function that can be deactivated. It is activated at a pre-determined date and time and for a selected duration.</p> <p>The d.h.w. temperature is acquired:</p> <ul style="list-style-type: none"> <li>• With 1 or 2 sensors</li> <li>• With 1 or 2 thermostats (not possible with solar d.h.w. heating)</li> </ul> <p>D.h.w. control also includes the control of a circulating pump and of an electric immersion heater. The impact of the legionella function on the circulating pump can be disabled. The d.h.w. storage tank can be forcedly charged once a day.</p>
<b>Remote control</b>	<ul style="list-style-type: none"> <li>• Changeover of operating mode with room unit QAW50</li> <li>• Overriding the major controller functions with room unit QAW70</li> <li>• Selection of another (programmable) operating mode with an external switch</li> <li>• Preselection of a boiler or flow temperature setpoint with an external contact. Adjustable are the type of setpoint (constant or minimum), its action (on the heating circuit or boiler), and the flow temperature</li> </ul>
<b>Note on QAW70</b>	<p>The day of the week is set automatically with the date by the controller; an adjustment from the room unit QAW70 is not possible.</p>

<b>Incoming heat demand signals</b>	<p>The RVL482 has two separately scalable DC 0...10 V inputs (corresponding to 0...x °C) to which heat demand signals from external consumers can be fed. The value of "x" can be adjusted in the range of 30...130 °C.</p>
<b>Communication</b>	<p>Communication with other devices takes place via data bus (LPB) and allows:</p> <ul style="list-style-type: none"> <li>• Signaling of heat demand to the heat source</li> <li>• Exchange of locking and enforced signals</li> <li>• Exchange of measured values such as outdoor temperature, return temperature, flow temperature and of clock signals</li> <li>• Integration of heat source cascades or heat source systems (heat pump, solar panels, wood-fired boiler)</li> <li>• Reception of heat demand signal from the SYNERGYR OZW30 central unit (with software version 3.0 or higher)</li> <li>• Exchange of error messages</li> </ul>
<b>Error messages and flow temperature alarm</b>	<ul style="list-style-type: none"> <li>• Error messages in the event of sensor, data bus or room unit faults</li> <li>• Flow temperature alarm; adjustable is the period of time during which the flow temperature / boiler temperature may stay outside the set limits; an error message is delivered when the set time has elapsed</li> </ul>
<b>Other functions</b>	<ul style="list-style-type: none"> <li>• One multifunctional relay. Choice of functions: Outdoor temperature switch, on / off according to the time switch, alarm contact in the event of error messages, on / off according to the occupancy time, on / off according to the occupancy time including optimization, on / off according to heat demand, on / off manually</li> <li>• Display of parameters, actual values, operating states and error messages</li> <li>• Simulation of outdoor temperature</li> <li>• Relay test; all relays can be controlled manually</li> <li>• Sensor test; all measured values from sensors and thermostats can be displayed</li> <li>• Testing the contacts connected to terminals H1–M and H2–M</li> <li>• Outdoor temperature-dependent frost protection for the plant; a minimum flow temperature is maintained; its setpoint and the response threshold can be adjusted</li> <li>• Pump overrun to prevent the buildup of heat</li> <li>• Periodic pump run (pump kick) to prevent seizing of the pumps in the summer</li> <li>• Controller hours run meter</li> </ul> <p>For more detailed information about data bus (LPB), refer to the following pieces of documentation:</p> <ul style="list-style-type: none"> <li>• Data Sheet Basic System Data LPB: N2030</li> <li>• Data Sheet Basic Engineering Data LPB: N2032</li> </ul>



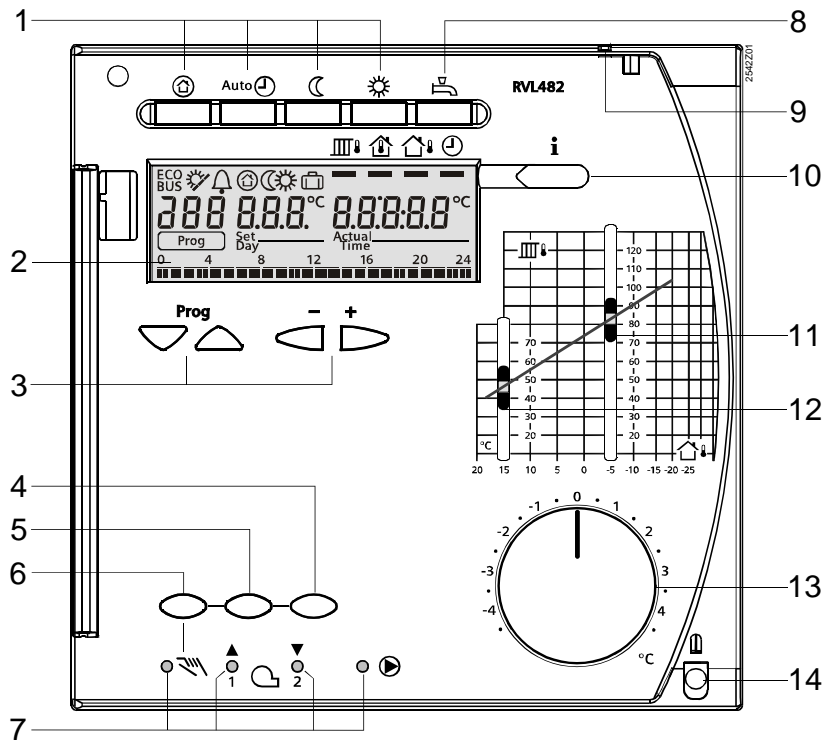

- 1 Operating mode buttons (selected button is lit)
- 2 Display (LCD)
- 3 Buttons for operating the display:  
Prog = selection of operating line  
- + = adjustment of displayed value
- 4 Button for "Close heating circuit mixing valve" or reduce modulation, or burner stage 2 ON/OFF in manual operation
- 5 Button for "Open heating circuit mixing valve" or increase modulation in manual operation
- 6 Button for manual operation
- 7 LEDs for:  
  - Manual operation
  - Heating circuit mixing valve opens / burner modulation actuator opens / burner stage 1 ON
  - Heating circuit mixing valve closes / burner modulation actuator closes / burner stage 2 ON
  - Pump runs
- 8 Button for d.h.w. heating ON/OFF (ON = button lit)
- 9 Sealing facility in the cover
- 10 Info button for the display of actual values
- 11 Setting slider for flow temperature setpoint at an outside temperature of -5 °C
- 12 Setting slider for room temperature setpoint at an outside temperature of 15 °C
- 13 Setting knob for readjustment of room temperature
- 14 Fixing screw with sealing facility

The RVL482 consists of controller insert, which accommodates the electronics, power section, output relays and – on the unit front – all operating elements, and base with the connection terminals. The operating elements are located behind a lockable transparent cover.

The operating instructions can be inserted in the transparent cover.

All values are read in the display (LCD) featuring background lighting.

The controller insert is secured to the base with 2 screws, one of which can be sealed.

The cover can also be sealed.

The RVL482 can be mounted in 3 different ways:

- Wall mounting (on a wall, in the control panel, etc.)
- Rail mounting (on a top hat rail)
- Flush panel mounting (control panel door, etc.)

## Analog operating elements

- Buttons for selecting the operating mode
- Button for d.h.w. heating on/off
- Info button
- Direct setting of heating curve by means of the little bar (only if analog setting is selected)
- Knob for manual readjustment of the room temperature
- 3 buttons for manual operation and for manual positioning commands

## Digital operating elements

Entry or readjustment of all setting parameters, activation of optional functions and reading of actual values and states is made according to the operating line principle. An operating line with an associated number is assigned to each parameter, each actual value and each function that can be selected.

One pair of buttons is used to select an operating line and one pair to readjust the display.

## Notes

---

### Engineering

- The wires of the measuring circuits carry extra low voltage
- Those to the actuators and the pumps carry AC 24...230 V
- The local safety regulations must be complied with

Sensor cables must not be run parallel to mains carrying cables for loads such as actuator, pump, burner, etc. (insulation class II EN 60730)

### Commissioning

The plant type must be configured.

## Disposal

---



In terms of disposal, the RVL482 are classified as electronic scrap conforming to the European Directive 2002/96/EG (WEEE) and must not be disposed of as domestic waste. The relevant national legal requirements must be complied with and the units must be disposed of through the relevant channels. Local and currently valid legislation must be observed.

## Warranty

---

**When using the RVL482 together with third-party devices not specifically mentioned, correct functioning must be ensured by the user. In that case, Siemens will assume no responsibility for service and warranty.**

## Technical Data

<b>Power supply</b>	Rated operating voltage	AC 230 V ( $\pm 10\%$ )		
	Frequency	50 Hz		
	Power consumption (no external load)	max. 9 VA		
	Supply line fusing	10 A		
<b>Output relays</b>	Switching capacity	AC 24...230 V		
	Switching current K4, K5, Q1, Y1, Y2, Y7, Y8	AC 0.02...2 (2) A		
	Switching current Q5, Q3, Q2 Q4, K6	AC 0.02...1 (1) A		
	Rated current of ignition transformer	max. 1 A (max. 30 s)		
	Switch-on current of ignition transformer	max. 10 A (max. 10 ms)		
<b>Permissible cable lengths to sensors and room unit</b>	Copper cable 0.6 mm $\varnothing$	20 m		
	Copper cable 0.5 mm <sup>2</sup>	50 m		
	Copper cable 1.0 mm <sup>2</sup>	80 m		
	Copper cable 1.5 mm <sup>2</sup>	120 m		
<b>Connection terminals</b>	Screw terminals for wire section	up to 2.5 mm <sup>2</sup>		
<b>Communication by wire</b>	Bus protocol/type	LPB		
	Bus loading characteristic E	9		
<b>Backup</b>	Backup of controller clock	12 h		
<b>Standards</b>	CE-conformance to EMC directive	2004/108/EC		
	– Immunity	– EN 61000-6-1 / -2		
	– Emissions	– EN 61000-6-3 / -4		
	Low voltage directive	2006/95/EC		
	– Safety	– EN 60730-1 / EN 60730-2-9		
<b>Protective data</b>	Safety class	II to EN 60730		
	Degree of protection (cover closed)	IP42 to EN 60529		
	Degree of contamination	2 to EN 60730		
<b>Dimensions</b>		refer to "Dimensions"		
<b>Weight</b>	Unit (net)	1.2 kg		
<b>Colors</b>	Controller insert	Light grey RAL 7035		
	Terminal base	Pigeon blue RAL 5014		
<b>Environmental conditions</b>		<i>Operation</i>	<i>Transport</i>	<i>Storage</i>
		EN 60721-3-3	EN 60721-3-2	EN 60721-3-1
	Climatic conditions	class 3K5	class 2K3	class 1K3
	Temperature	0...+50 °C	–25...+70 °C	–20...+65 °C
	Humidity	<95 % r.h. (non-condensing)	<95 % r.h.	<95 % r.h. (non-condensing)
	Mechanical conditions	class 3M2	class 2M2	class 1M2
	Use above sea level	max. 3000 m above sea level		

Connection diagrams

Low voltage side

Basic connections for plants with external heat demand signals

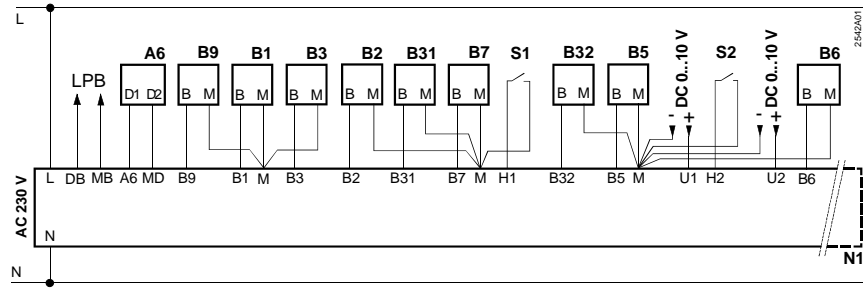

Basic connections for plants with solar impact and wind sensors

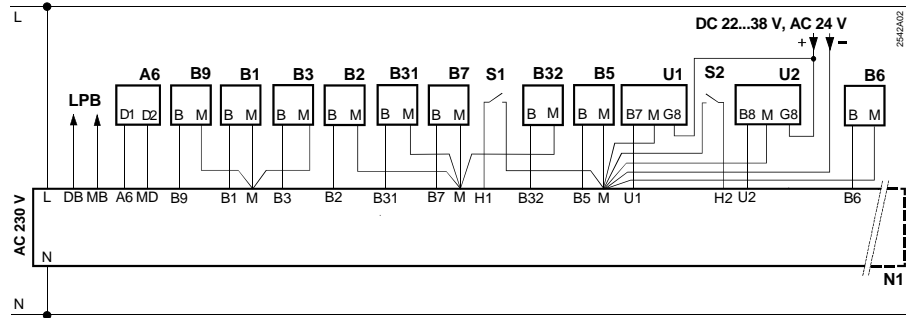

Mains voltage side

Basic connections for plants with 2-stage burner

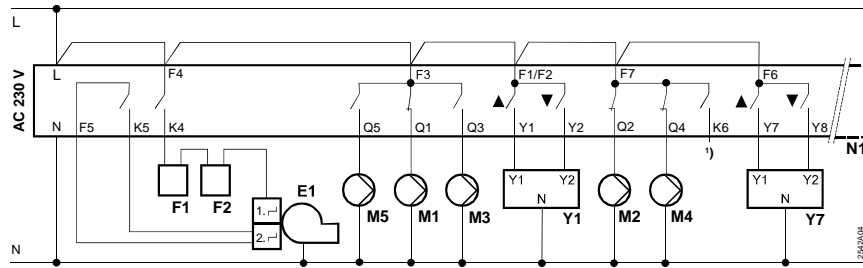

Basic connections for plants with modulating burner

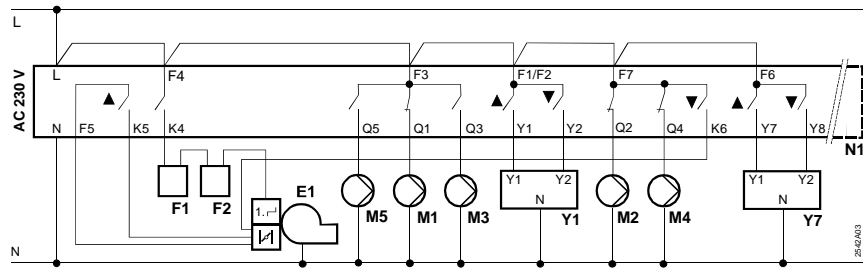

- |     |   |    |  |
|-----|---|----|--|
| A6  | Room unit   | M1 | Circulating pump / bypass pump                             |
| B1  | Flow sensor                                       | M2 | Heating circuit pump                                       |
| B2  | Boiler sensor                                     | M3 | Charging pump  |
| B3  | Flow sensor for d.h.w.                            | M4 | Boiler pump / circulating pump                             |
| B31 | D.h.w. storage tank sensor / control thermostat 1 | N1 | Controller RVL482  |
| B32 | D.h.w. storage tank sensor / control thermostat 2 | S1 | Remote operation for operating mode                        |
| B5  | Room sensor                                       | S2 | Remote operation for the flow temperature setpoint         |
| B6  | Collector sensor                                  | M5 | Collector pump   |
| B7  | Return sensor                                     | U1 | Solar impact sensor  |
| B9  | Outside sensor                                    | U2 | Wind sensor  |
| E1  | 2-stage or modulating burner                      | Y1 | Actuator heating circuit                                   |
| F1  | Limit thermostat                                  | Y7 | Actuator d.h.w. circuit or return temperature mixing valve |
| F2  | Safety limit thermostat                           |    |  |
| LPB | Data bus  | 1) | Multifunctional output                                     |

## Dimensions

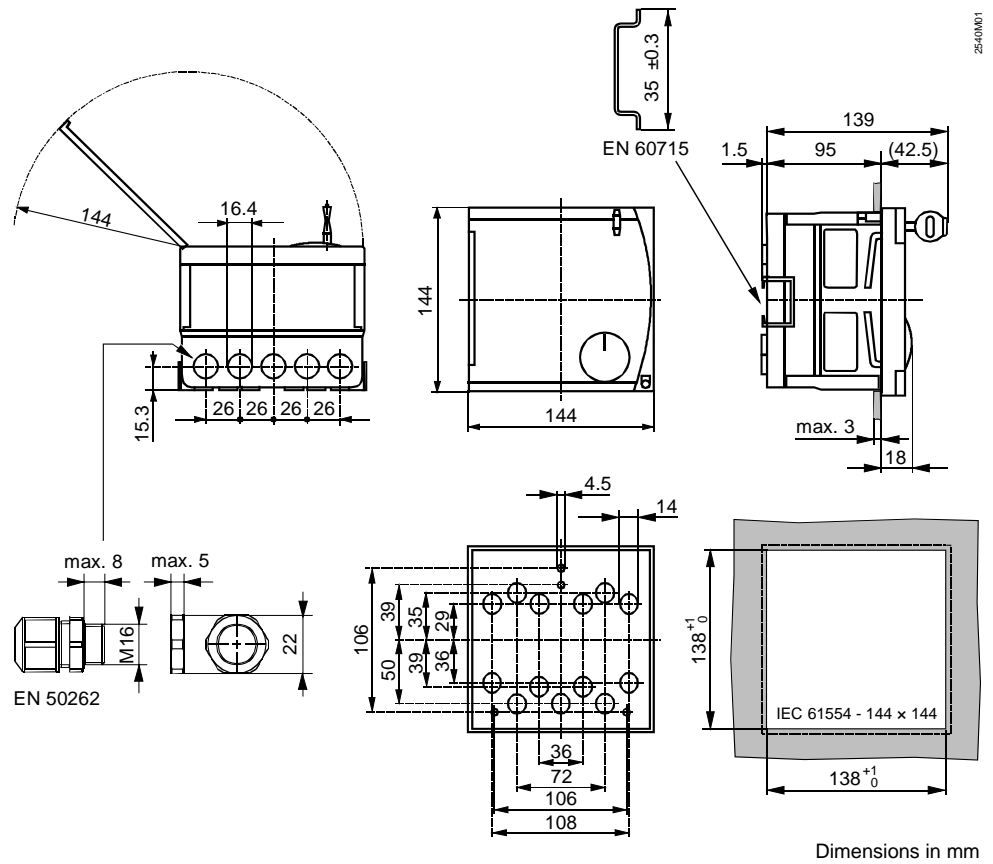

2540M01